

10A AND 20A COINLESS TELEPHONE SET AND KS-22284 BACKBOARD IDENTIFICATION, INSTALLATION, TESTS, MAINTENANCE, AND CONNECTIONS

1. GENERAL

1.01 This section provides information on:

- (a) The 10A coinless telephone set (Fig. 1)
- (b) The 20A coinless telephone set (Fig. 2)
- (c) The KS-22284 backboard (Fig. 3)
- (d) The 2554-type telephone sets (Fig. 3).

Note: Modification to the 2554BM-03 and 2554BMP-03 telephone sets will be necessary to replace modular jacks with hard wire to make the set nonmodular.

1.02 This section is reissued to add:

- 20A coinless telephone set
- D-180941 Kit of Parts (illumination package)
- 70B dial.

Since this reissue covers general revision, arrows ordinarily used to indicate changes have been omitted.

1.03 The coinless telephone set is intended for use in locations where present coin phones are serving high volume of credit card, collect, or billed to a third party calls. Signs associated with this service are displayed as "Charge-a-Call."

2. IDENTIFICATION

A. 10A Coinless Telephone Set (Fig. 1, 4, and 6)

2.01 The 10A coinless telephone set is designed to be installed on any backboard or enclosure

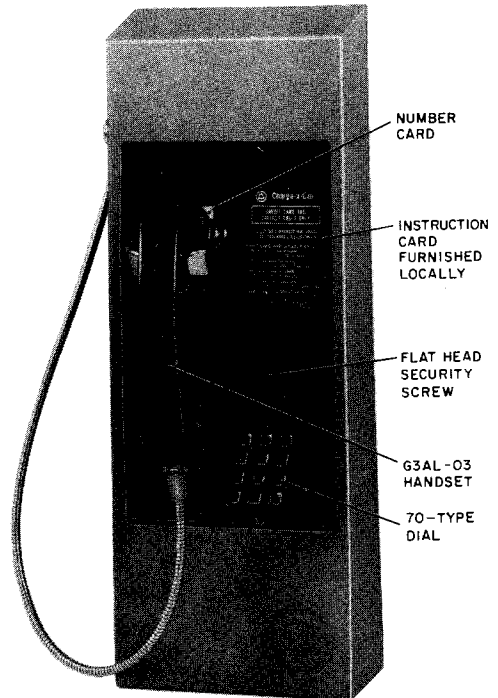

Fig. 1—10A Coinless Telephone Set

that will accept a 1-type coin telephone set; however, when a recessed enclosure is encountered, such as the SENTRY* mounting or wedge shelf, a KS-22171, List 1 adapter (Fig. 6) is required.

*Trademark of Western Electric

NOTICE

Not for use or disclosure outside the
Bell System except under written agreement

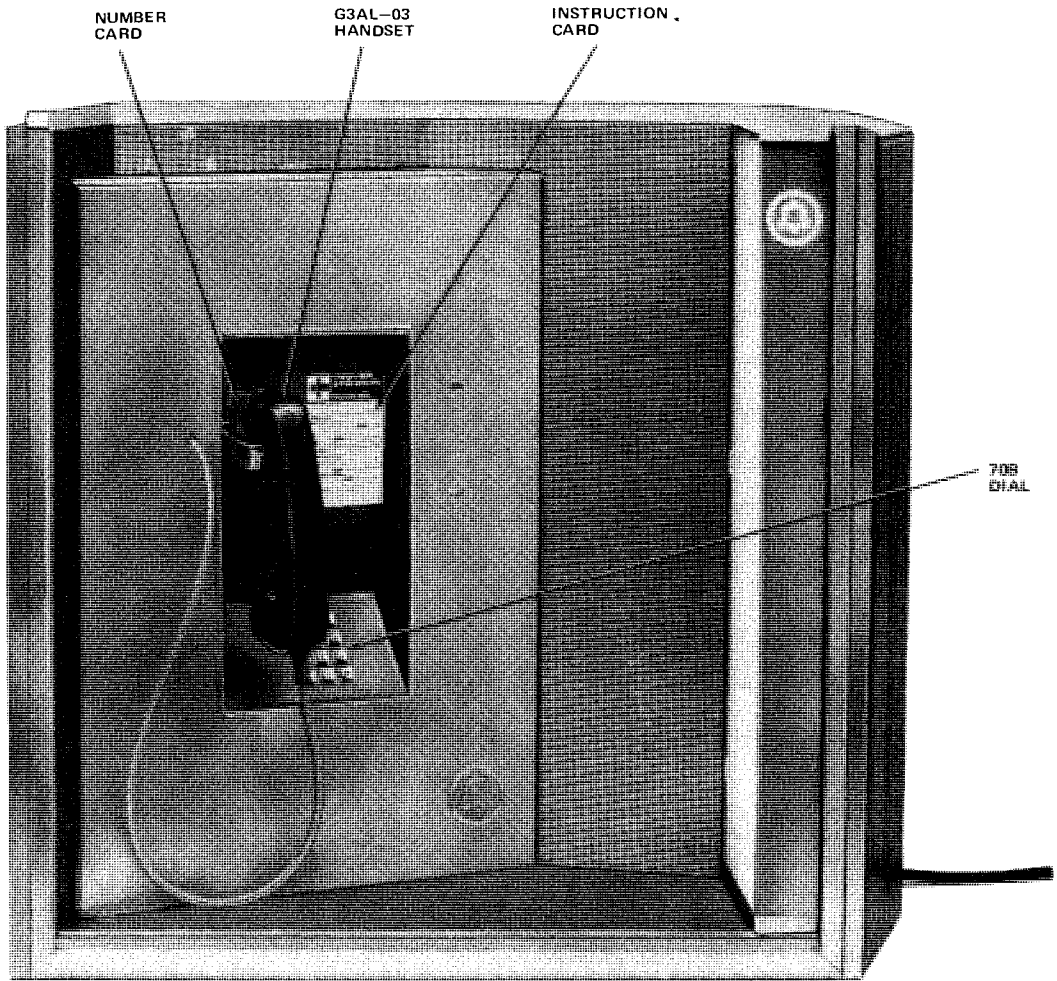

Fig. 2—20A Coinless Telephone Set

2.02 Each set consists of a rear pan assembly and a front cover assembly (Fig. 4). These two assemblies are connected electrically by a 2-foot long D4CD-49 line cord.

2.03 The front cover assembly is secured to the rear pan assembly with a flat head security screw.

2.04 The set is made of steel and painted Corporate Bell Blue with a Bell symbol on the front surface.

2.05 A terminal board (TB1) is furnished on the rear pan assembly for terminating station wiring.

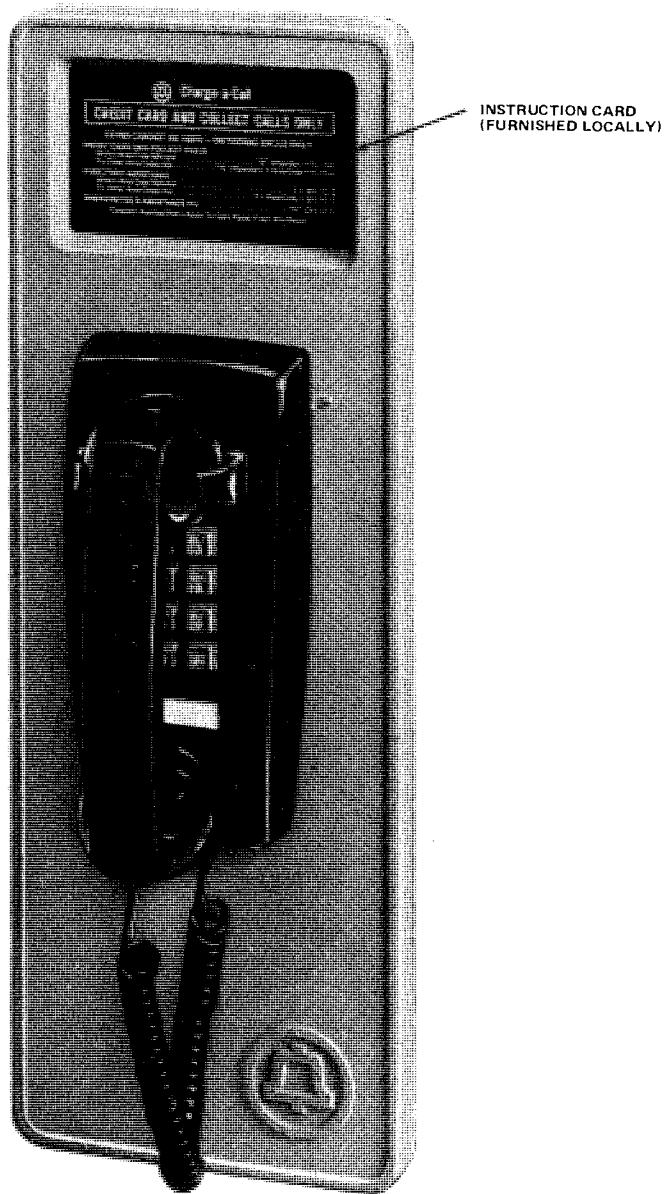

Fig. 3—KS-22284 Backboard With 2554-Type Telephone Set

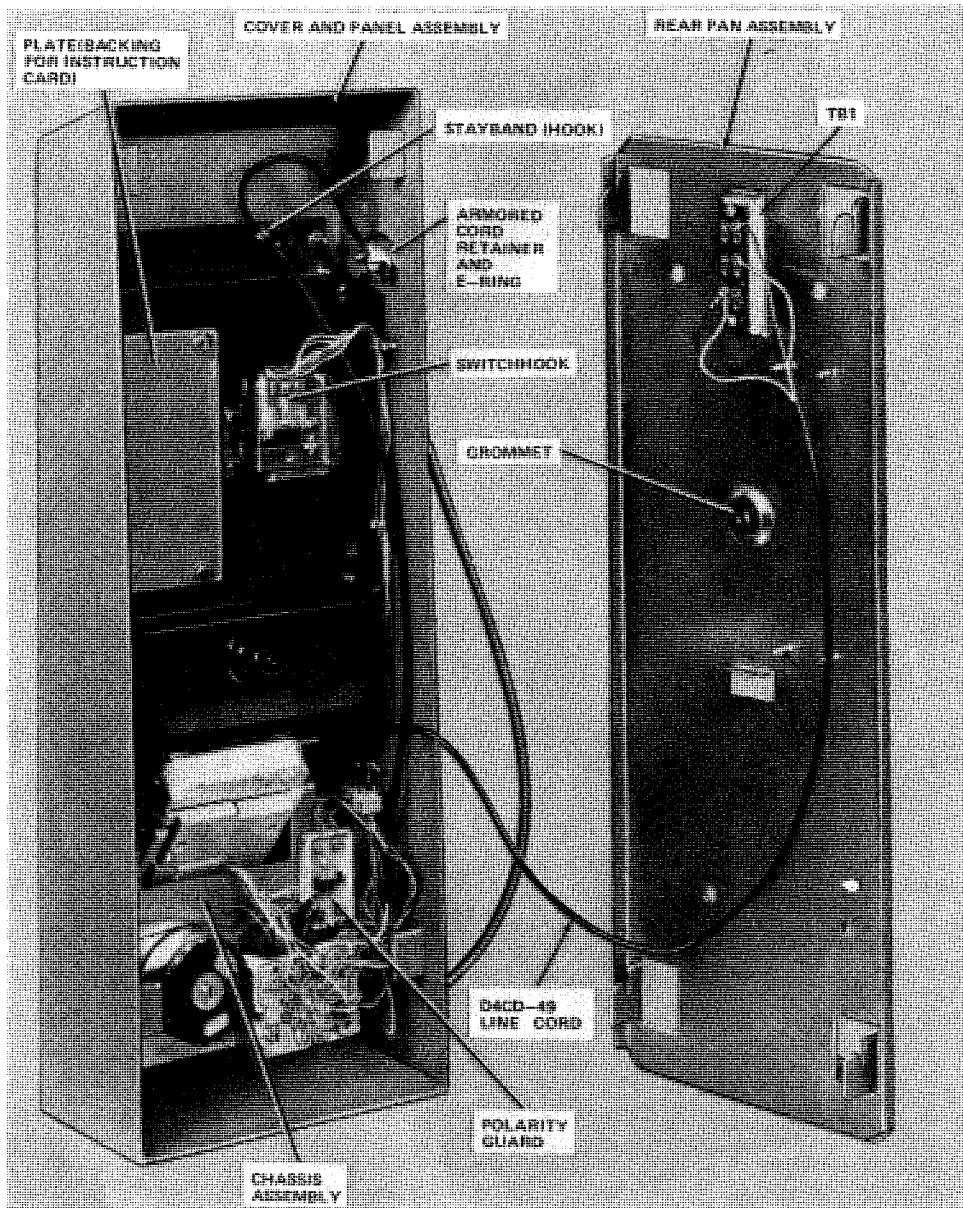

Fig. 4—10A Coinless Telephone Set With Rear Pan Assembly Removed

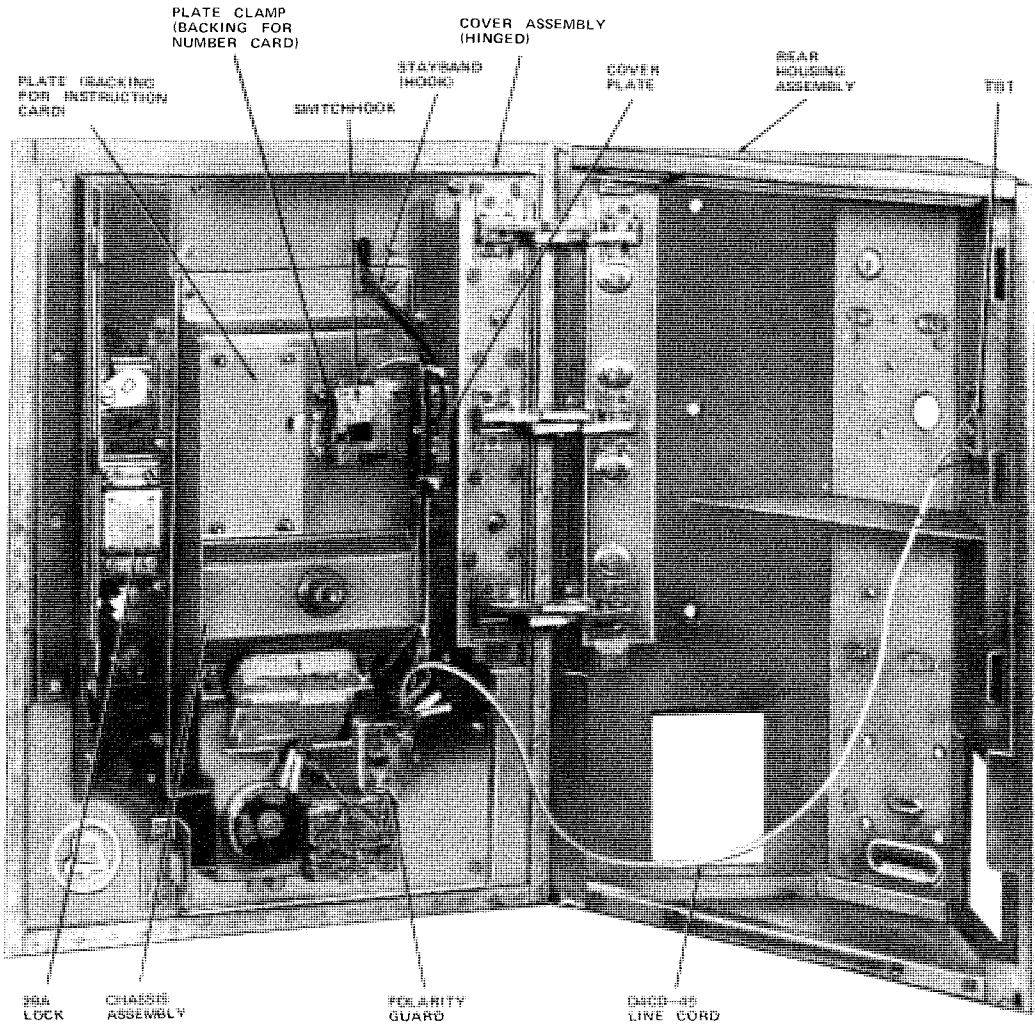

Fig. 5—20A Coinless Telephone Set With Cover Assembly Opened

- 2.06 The instruction card (Fig. 1 and 7) must be fabricated and procured locally.
- 2.07 The 10A coinless set contains the following components:
- 70B or 70A (MD) dial
 - G3AL-03 Handset which includes a H4EJ Cord
 - P1B Ringer
 - 4228B Network.

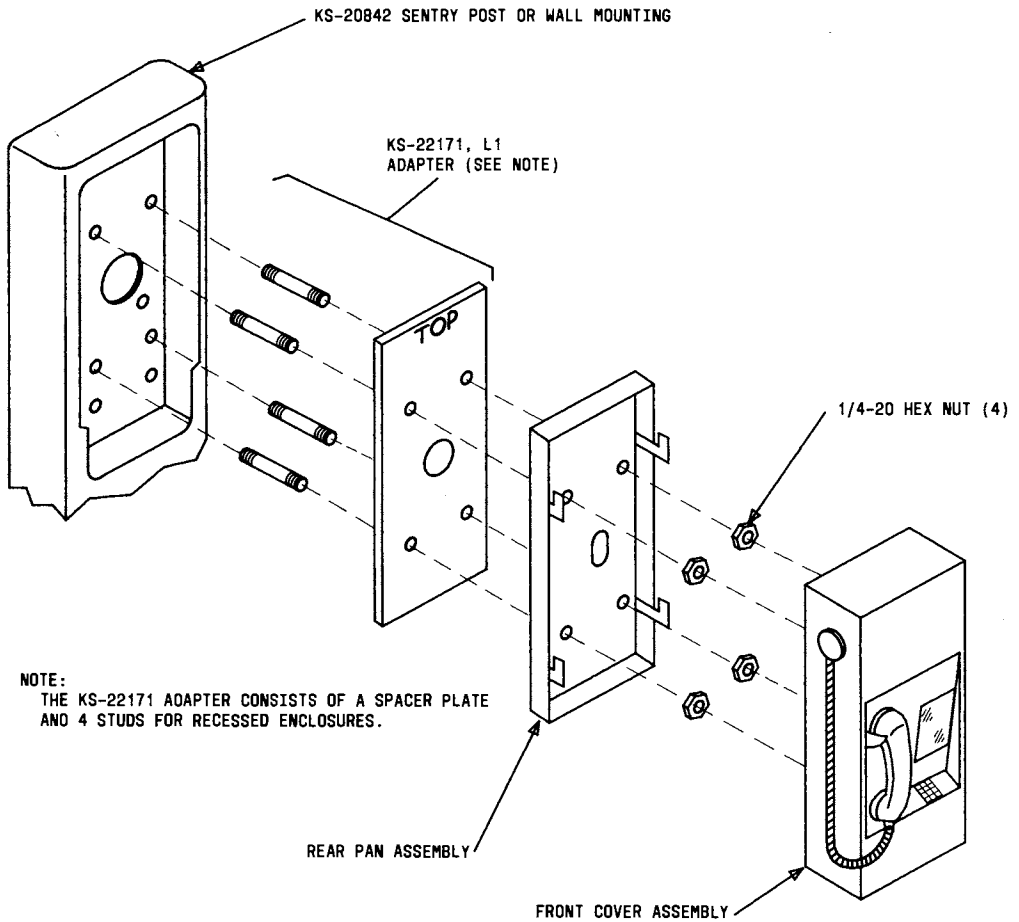

Fig. 6—10A Coinless Telephone Set Used With Adapter

2.08 Overall dimensions of the 10A coinless set are:

- Height—21 inches
- Width—7-9/16 inches
- Depth—4 inches.

2.09 There are no provisions for using security studs with this set.

2.10 This set has no coin handling features.

B. 20A Coinless Telephone Set (Fig. 2 and 5)

2.11 The 20A coinless telephone set is designed to be installed in any enclosure or mounting which accepts the 2-type (panel) coin telephone sets.

2.12 Each set consists of a rear housing assembly and a hinged cover assembly (Fig. 5). The cover assembly includes a brushed stainless steel

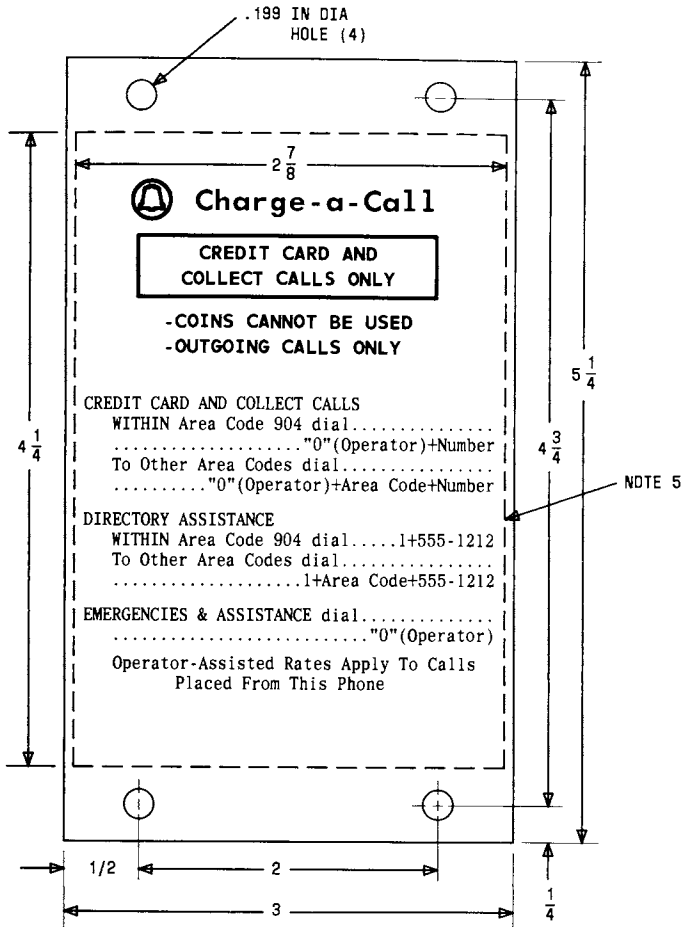

NOTES:

1. INSTRUCTION CARD FORMAT IS FOR EXAMPLE ONLY.
2. MATERIAL MAY BE A RIGID LAMINATED PLASTIC OR OTHER MATERIAL WITH PROTECTED OR DURABLE SURFACE. RECOMMENDED THICKNESS - .045" TO .050".
3. ALL DIMENSION SHOWN ARE IN INCHES.
4. THE OPENING IN FRONT OF SET IS 2 7/8 X 4 1/4. ENSURE THAT INSTRUCTIONS ARE NOT PRINTED BEYOND THIS VISIBLE AREA

Fig. 7—Instruction Card for 10A or 20A Coinless Telephone Set (Typical)

SECTION 506-500-100

faceplate with beveled edges and a recessed panel assembly painted Corporate Bell Blue.

2.13 The hinged cover assembly is held closed by a latching mechanism operated by the 719A tool and a 29A lock. The lock must be provided and installed by the telephone company.

2.14 A terminal (TBI) is furnished on the rear pan assembly for terminating station wiring.

2.15 The instruction card (Fig. 2 and 7) must be fabricated and procured locally.

2.16 The 20A coinless set contains the following components:

- 70B Dial
- G3AL-03 handset which includes a H4EJ cord
- P1B ringer
- 4228B network.

2.17 The overall dimensions of the 20A coinless set are the same as those of the 2-type coin sets. See Fig. 8.

2.18 Security studs may be used with this set.

2.19 The set has no coin handling features.

C. KS-22284 Backboard (Fig. 3 and 9)

2.20 The KS-22284 backboard is intended as a mounting apparatus to mount a black, nonmodular 2554-type telephone set indoors for "Charge-a-Call" public telephone service in lieu of the 10A coinless telephone set.

2.21 The backboard is a two-piece assembly which consists of a rear panel support and a front mounting panel. The two pieces are made of Bell System blue colored plastic. Mounting hardware is furnished.

2.22 Any closure that will accept a 1-type coin telephone set will accept this backboard, however, when a recessed enclosure is encountered, such as the SENTRY mounting or wedge shelf, a KS-22171, List 1 adapter (Fig. 10) is required.

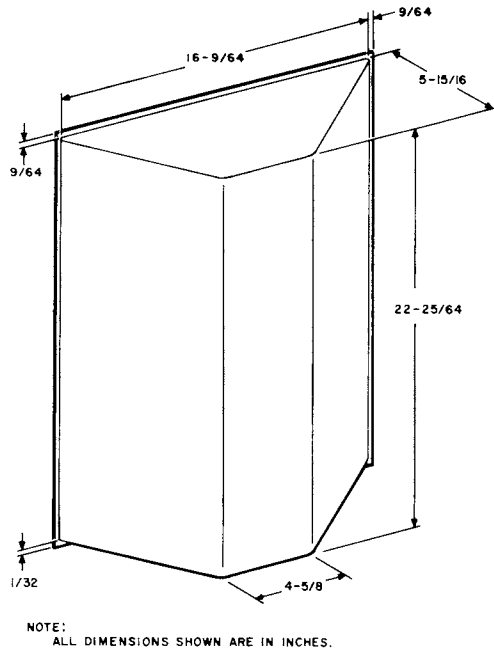

Fig. 8—Rear View of 20A Coinless Set Showing Dimensions

2.23 The rear panel has four holes compatible with the coin set mounting holes on the 178A backboard to facilitate installation when the 178A is present; however, the rear panel can be mounted directly to a wall.

2.24 The instruction card (Fig. 3 and 11) must be fabricated and procured locally.

3. INSTALLATION

A. 10A Coinless Telephone Set

3.01 Install the rear pan assembly on a 178A backboard or on any enclosure that will accept a 1-type coin telephone set. Use four 1/4-20 by 5/8 RHM screws.

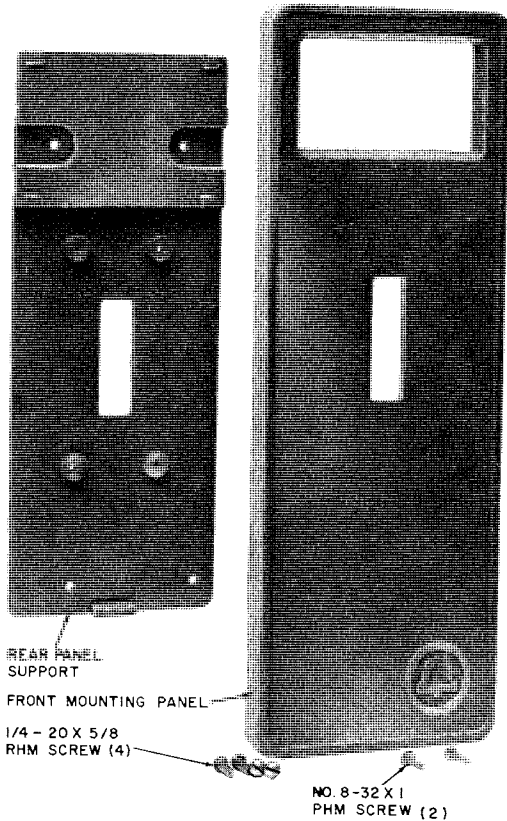

Fig. 9—KS-22284 Backboard

Note: On the KS-21571 deluxe wedge shelf and KS-20842 SENTRY mounting, a KS-22171, List 1 adapter is required (Fig. 6).

- 3.02** Run inside wire through grommet (Fig. 4) and terminate on TB1 per Fig. 17. Be sure that bonding and grounding practices are followed as described in Sections 460-100-400, 506-100-100, and 508-100-100.
- 3.03** Install instruction card in front cover assembly as follows.
- (1) Remove four No. 8-32 hex nuts and remove plate from instruction card opening (Fig. 4).

- (2) Insert instruction card (procured locally) into the opening and secure with the plate and four No. 8-32 hex units removed in Step (1).

3.04 Install number card (procured locally) as follows.

- (1) Remove two No. 8-32 hex nut and 840994453 plate clamp that secures number card window 812169480 (P-21F948) in faceplate.

- (2) Insert number card in window from rear.

- (3) Secure window and number card using the plate clamp and two hex nuts removed in Step (1).

3.05 Using a KS-19192, List 1 tool, back the security screw (located in the center of the front cover) out to where it is flush with the threaded nut.

3.06 Hold the front cover assembly close to the rear pan assembly and connect P1 of the D4CD-49 line cord to J1 located on rear of front cover.

Note: Do not release the front cover and allow the D4CD cord to support its weight.

3.07 Carefully dress cord in rear pan assembly so as not to interfere with switchhook or latching tabs and install front cover assembly by pushing back and down.

3.08 Secure cover to pan by tightening the security screw securely.

B. 20A Coinless Telephone Set

3.09 Install the set in the enclosure or other mounting, using the thirteen 1/4-20 by 5/8 RHM screws which are shipped with the set. The hole locations in the housing are identical to those in the 2-type coin telephone sets.

3.10 Run inside wire through one of the large holes in the rear of the housing and terminate on TB1 per Fig. 5 and 17.

3.11 Install instruction card in front panel assembly as described in paragraph 3.03.

3.12 Install number card as described in paragraph 3.04.

3.13 Install 29A lock in front panel.

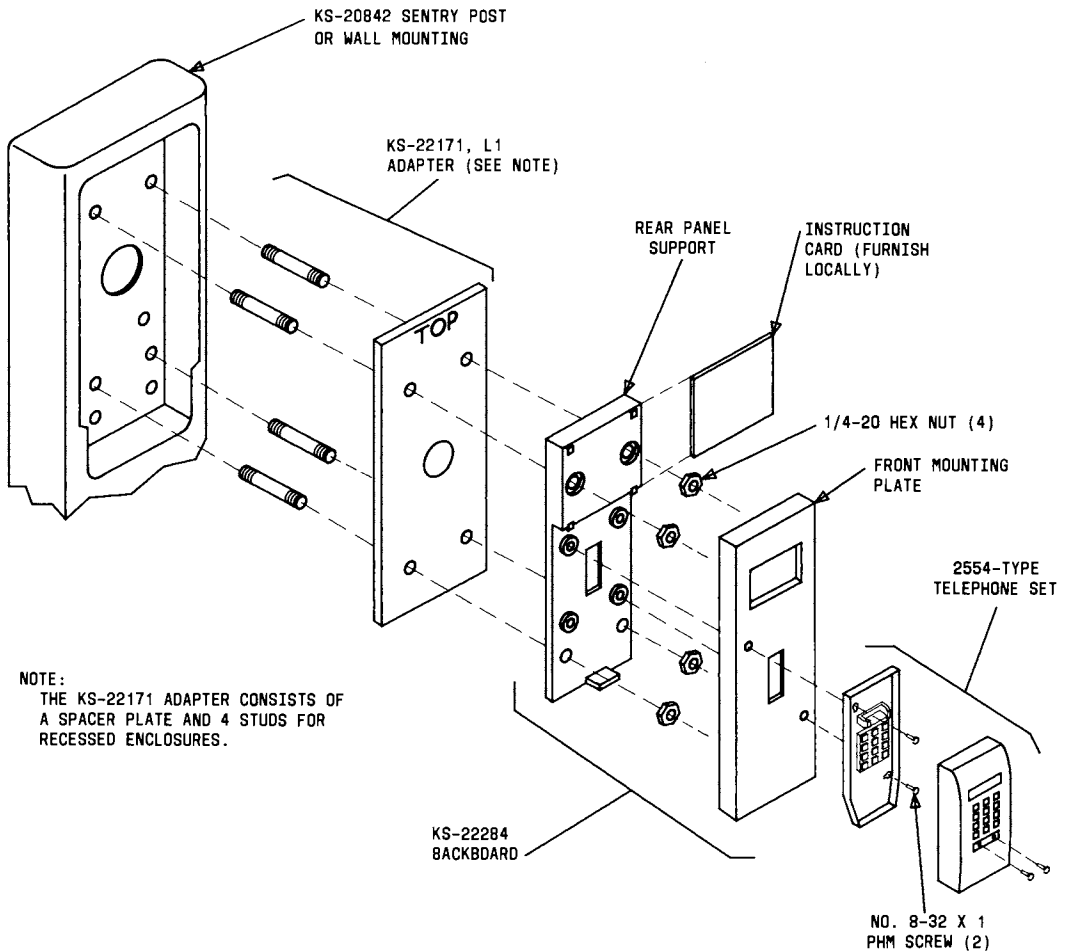

Fig. 10—KS-22284 Backboard and 2554-Type Telephone Set Used With Adapter

C. KS-22284 Backboard (Fig. 9)

3.14 Install the rear panel support on a 178A backboard or on any enclosure that will accept a 1-type coin telephone set. Use four 1/4-20 by 5/8 RHM screws furnished.

Note: For a recessed enclosure (SENTRY Mounting and Wedge Shelf) use a KS-22171, List 1 adapter (Fig. 10).

3.15 The backboard can be installed on a wall without the aid of a 178A backboard. This is accomplished as follows.

(1) Mark the location for the rear panel support using the following guidelines.

- Distance from top of rear panel support to floor will be 55 inches.

(2) Refer to Division 080 for method of installing fasteners.

(3) Secure support to wall using fasteners described in Table A.

3.16 Install the locally procured instruction card as follows.

NOTES:

1. INSTRUCTION CARD FORMAT IS FOR EXAMPLE ONLY.
2. MATERIAL MAY BE A RIGID LAMINATED PLASTIC OR OTHER MATERIAL WITH PROTECTED OR DURABLE SURFACE. THICKNESS MUST BE .045" TO .050".
3. ALL DIMENSIONS SHOWN ARE IN INCHES.
4. THE OPENING IN FRONT OF SET IS 3 X 5-1/4. ENSURE THAT INSTRUCTIONS ARE NOT PRINTED BEYOND THIS VISIBLE AREA.

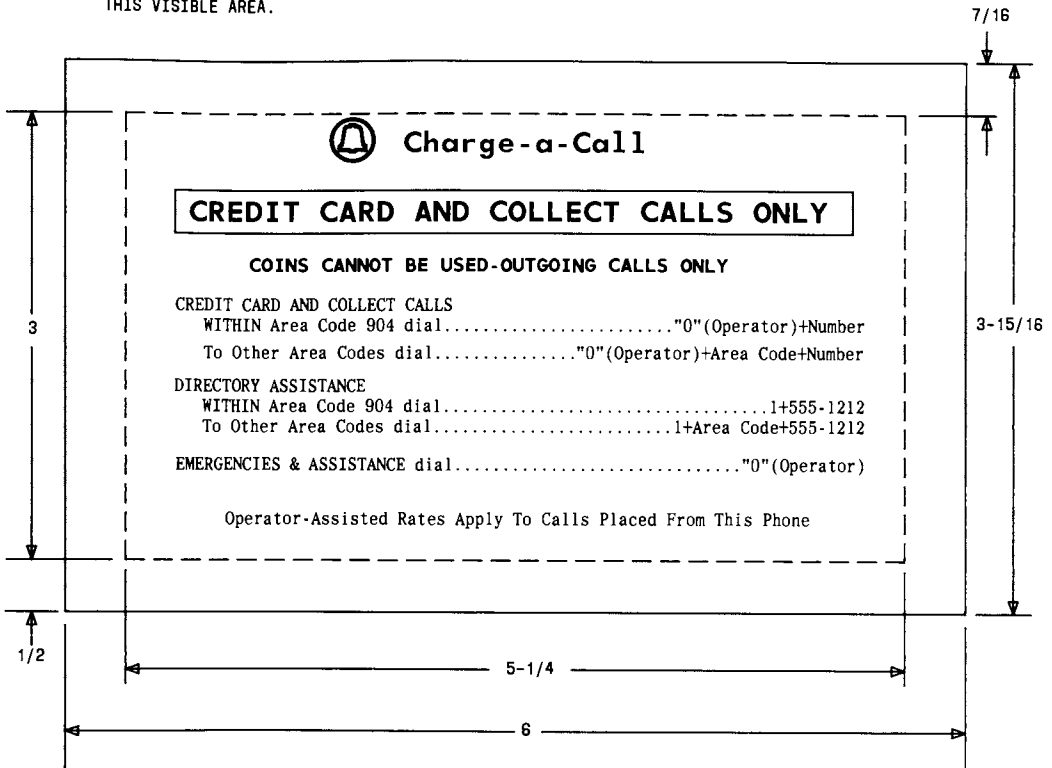

Fig. 11—Instruction Card for KS-22284 Backboard (Typical)

- (1) Place top of card under tabs on panel (Fig.12).
- (2) Push back and down under bottom tabs.
- (3) Ensure that card is seated properly.

D. 2554B-03 (MD), Modified 2554B-03 (MD), or Modified 2554BMP-03 Telephone Set

Note: The nonmodular 2554B-03 (MD) set is desired for "Charge-a-Call" service when using the KS-22284 backboard; however, a 2554BM-03 (MD) or 2554BMP-03 wall set can be modified and used for this purpose.

3.17 Place the front mounting panel over the rear panel support and install two No. 8-32 by 1 PHM screws furnished (Fig. 10). Do not tighten the two screws; they are also used to mount the base of the wall set.

3.18 Modify a 2554BM-03 (MD) or 2554BMP-03 set as follows.

TABLE A
FASTENERS USED TO SECURE KS-22284 BACKBOARD TO WALL

MOUNTING SURFACES					HOLE SIZE REQUIRED	FASTENERS	
SOFT-WOOD	HARD-WOOD	MASONRY (CONCRETE, BRICK) (NOTE 1)	PLASTER BOARD AND PLASTER ON LATH (NOTE 2)	PLASTER ON CINDER BLOCK, HOLLOW TILE, METAL LATH		SIZE AND TYPE	QUANTITY
•					1/8 or No. 30	1-3/4 inch No. 14 RH tapping screw	4
	•					1-1/4 inch No. 14 RH tapping screw	
		•			1/2	1/4-20 by 1-1/2 inch RH machine screw in 1/4 by 1-1/4-inch expansion shield	
			•		1/8 or No. 30	1-3/4 inch No. 14 RH tapping screw, secure in stud a minimum of 1 inch	
				•	3/4	1/4- by 4-inch RH toggle bolt (Note 3)	

Note 1. When mounting on plastered masonry, install expansion shield below plastered surface by amount equal to thickness of plaster and use 1/2-inch longer machine screw than specified in table.

Note 2. When mounting on plasterboard, plaster on lath, etc, fasteners must be embedded in stud at least 1 inch.

Note 3. When using toggle bolts, cut off excess length.

- (a) Disconnect the H4DU handset cord, if present, from the base and handset.
- (b) Remove the set housing.
- (c) Disconnect and remove the 616B handset cord jack from base.
- (d) If a set is equipped with a 229-type adapter (refer to Section 503-100-100) remove the adapter.

Note: The nonmodular G3A6-03 handset is desired for this modification; however, a G15A-03 handset can be modified and used for this purpose.

- (e) Modify a G15A-03 handset as follows.
 - (1) Remove the 616W jack from handset.
 - (2) Install a H4CJ-03 cord in the handset, making sure the cotton ball is replaced.
- (f) Connect the handset cord of a G3A6-03 or modified G15A-03 handset to the set base per Table B.
- (g) Install a 124A apparatus blank on the base to secure the cord.

TABLE B

HANDSET CORD CONNECTIONS FOR 2554-TYPE TELEPHONE SET

TYPE NETWORK	HANDSET CORD WIRE COLOR	CONNECT TO
4010-Type	BK	B on Network
	R	11 on Term. Strip
	W	R on Network
	W	10 on Term. Strip
4228-Type	BK	B on Network
	R	T on Network
	W	R on Network
	W	S on Network



Fig. 12—Installing Instruction Card On Rear Panel Support of KS-22284 Backboard

3.19 Install a 2554B-03 (MD), modified 2554BM-03 (MD), or modified 2554BMP-03 set on a KS-22284 backboard (Fig. 13) as follows.

- (a) Run station wire through opening in backboard and through opening in base of set. If set is a 2554BMP-03, run wire through opening past the 523A3 plug.
- (b) Hang the base on the two PHM screws installed in paragraph 3.17 and tighten the two screws.
- (c) Connect station wire per Table C.
- (d) Install set housing.

4. TESTS (For all Coinless Public Telephone Sets)

Note: Refer to test desk if any of the following tests fail.

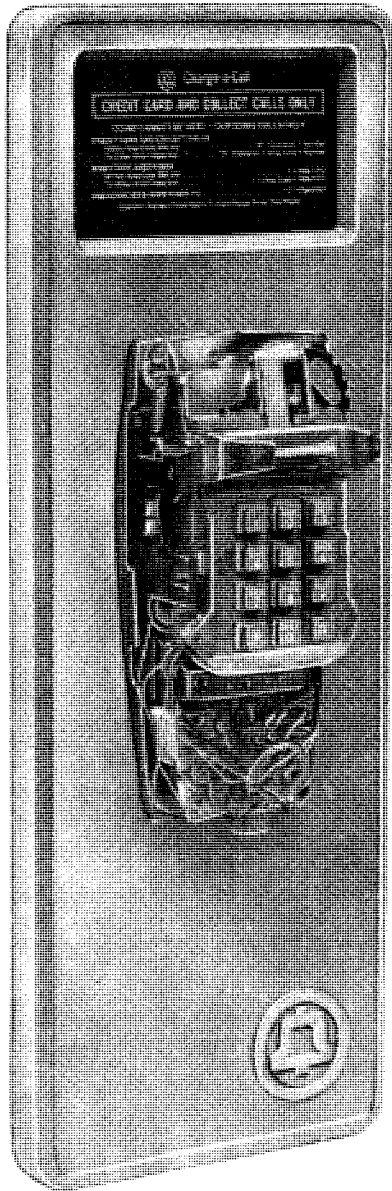

Fig. 13—Installing 2554-Type Telephone Set On Backboard

TABLE C

STATION WIRE CONNECTIONS FOR 2554-TYPE TELEPHONE SET

TYPE NETWORK	STATION WIRE	CONNECT TO
4010-Type	Tip	1 on Term. Strip
	Ring	2 on Term. Strip
	Ground	3 on Term. Strip
4228-Type	Tip	L1 on Network
	Ring	L2 on Network
	Ground	G on Network

4.01 *Without dialing "0".*

- (1) Dial a local charge number and verify that call is blocked.
- (2) Initiate a station-to-station toll call and verify that call is blocked.
- (3) If central office is equipped with unrestricted-ring-back on noncoin lines verify that operator can ring back, using ring-back key after hang-up.

4.03 *Denied termination of service check.*

- (1) Go to adjacent coin station and attempt to call "Charge-a-Call" station.
- (2) Charge-a-Call station should not ring. Proper announcement should be heard and money should be returned.

4.02 *Dial "0".*

- (1) Have operator verify coinless class of service.
- (2) Have operator verify correct number assignment.

5. MAINTENANCE

- 5.01 Maintenance will consist of replacing components shown in Fig. 1 through 17.

A. 10A Coinless Telephone Set**5.02** To replace switchhook.

- (a) Remove handset from switchhook.
- (b) Disconnect switchhook leads from network and polarity guard (Fig. 17).
- (c) Pull cable out from cable ties.
- (d) Remove four 841067283 PH thread forming screws that secure bracket to front panel.
- (e) Lift switchhook out.
- (f) To install, use reverse procedure.

Note: Mounting screws for the switchhook assembly are thread forming. Exercise care to avoid cross threading.

5.03 To replace switch assembly on switchhook.

- (a) Disconnect switchhook leads from network and polarity guard (Fig. 17).
- (b) Pull cable out from cable ties.
- (c) Remove one No. 4-40 by 3/8 hex head screw from the switch assembly (Fig. 4).
- (d) Carefully lift switch off being careful to keep the slide in place.
- (e) Transfer slide to the new switch.
- (f) Mount new switch with slide attached while inserting switchhook actuator in slide.
- (g) Secure switch with the No. 4-40 by 3/8 hex head screw removed in Step (c).
- (h) Run cable through cable ties and connect wires per Fig. 17.

5.04 To replace G3AL-03 handset.

- (a) Disconnect handset leads (Fig. 17) and loosen screw to remove stayband (hook) which anchors leads to upper part of housing.
- (b) Remove the "E" ring from around armored cord retainer on inside of cover (Fig. 4).

- (c) Pull cord retainer from cover and remove from cord.

- (d) Install using reverse procedure and dress the cable down the channel in corner of cover. Stayband should be fastened to housing as shown in Fig. 4. To insure proper dressing of cord.

5.05 To replace 842621930 chassis assembly.

Note: This assembly contains the ringer, network, and polarity guard.

- (a) Loosen two No. 8-32 hex nuts at bottom of chassis.
- (b) Remove two No. 8-32 hex nuts from top of chassis.
- (c) Disconnect all wiring from the network and polarity guard.
- (d) Pull chassis up and out.
- (e) To install, use reverse procedure.

5.06 To replace 70-type dial.

- (a) Remove 842621930 chassis assembly per paragraph 5.05, except only the dial leads need be removed from network.
- (b) Remove two additional hex nuts that secure dial brackets.
- (c) Pull dial and dial brackets away from cover.
- (d) Loosen the two dial mounting screws and transfer the dial mounting brackets to the new dial.
- (e) Install using reverse procedure and make connections per Fig. 17.

5.07 To replace polarity guard (842621955 printed wiring board assembly).

- (a) Disconnect the two wiring board leads from the network.
- (b) Remove one No. 8-32 by 3/8 thread forming screw (Fig. 4) and remove dust cover.

SECTION 506-500-100

- (c) Disconnect two switchhook leads from printed wiring board.
- (d) Lift printed wiring board off chassis.
- (e) Install using reverse procedure and connect leads per Fig. 17.
- (f) The same printed wiring board assembly is used in D-180893 Kit of Parts. In that kit, however, the leads are attached to different terminals on the polarity guard, and must be changed to agree with Fig. 17. The kit also contains a bracket which is not used in the coinless set and should be discarded.

5.08 To modify the nonilluminated instruction card to an illuminated instruction card in the 10A coinless telephone set, using D-180941 Kit of Parts, (Fig. 14) proceed as follows.

- (1) Remove the cover and panel assembly from the rear pan assembly.
- (2) On the cover and panel assembly remove the four nuts which retain the metal instruction card stiffener. Remove the stiffener and the instruction card.
- (3) Install the 1/16 inch clear plastic shield over the four studs. Then install the translucent information card (furnished by the operating company) over the clear plastic shield. Next install the 1/8-inch clear plastic stiffener over the instruction card. The plastic stiffener is retained by the four nuts (Fig. 15) which retained the metal stiffener.
- (4) Next the rear pan assembly is modified. The printed circuit board, which has two metal brackets riveted to it, is mounted over the four studs protruding from the pan. The circuit board assembly is fastened in place by using the four 8-32 nuts supplied in the kit. The circuit board must be mounted with the screw terminals at the bottom as shown in Fig. 16. The 24 light emitting diodes are powered by the 2012A (MD) or 2012C transformer supplied in the kit. Two 27 gauge wires (furnished by the operating company) are connected between the transformer and the two screw terminals on the printed circuit board. The transformer will

require a 115 volt ac outlet, to be supplied by the operating company.

Note: Upon completion of the modification the craftsman should be sure the LEDs are lit before replacing the cover.

- (5) Connect the cover to the rear pan electrically, using the modular cord. Mount the cover to the rear panel and secure with retaining screw.

Note: The modified instruction card should exhibit a greenish-yellow glow when the power is turned on. When the power is off the translucent instruction card will produce adequate visibility of the printed information.

B. 20A Coinless Telephone Set

5.09 Maintenance of the 20A set is the same as for the 10A set described in paragraphs 5.01 through 5.07, except for handset replacement, paragraph 5.04.

5.10 To replace the G3AL-03 handset.

- (a) Disconnect handset leads and loosen screw to remove stayband (hook).
- (b) Remove the two nuts which retain the coverplate (with key-hole slot) and remove coverplate from cord.
- (c) Install new handset, using reverse procedure.

C. 2554-Type Telephone Set

5.11 Refer to Section 502-503-101.

6. CLEANING

6.01 Clean sets and backboard in accordance with Section 508-100-101.

7. CONNECTIONS

7.01 Refer to Fig. 17 for connections on the 10A or 20A coinless telephone set.

7.02 Refer to Section 502-523-402 for connections on the 2554-type telephone set.

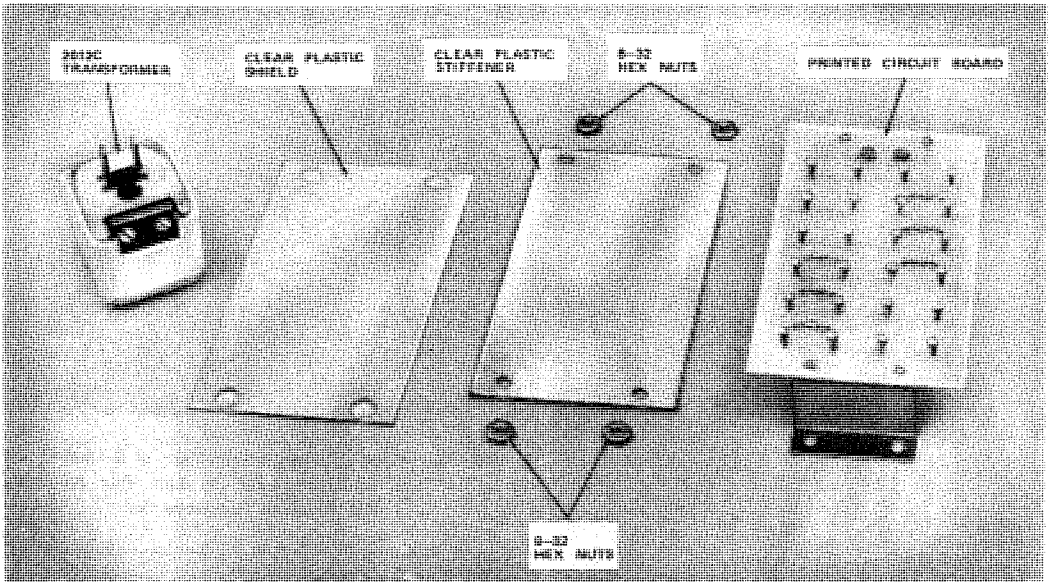

Fig. 14—D-180941 Kit of Parts

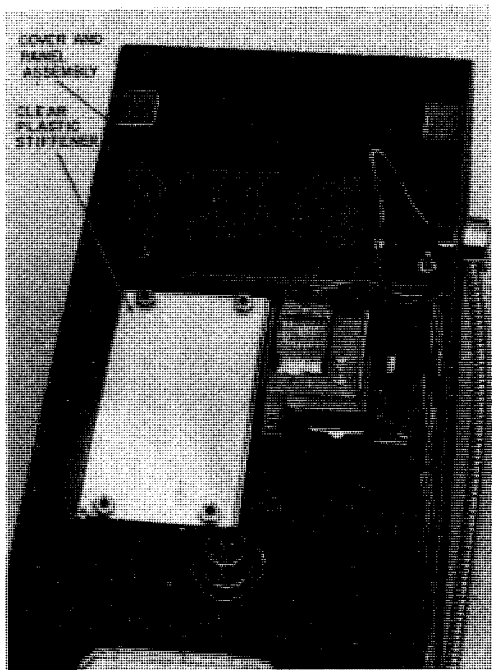

Fig. 15—Stiffener (Part of D-180941 Kit of Parts) Installed Over Shield and Information Card on Cover and Panel Assembly of 10A Coinless Telephone Set

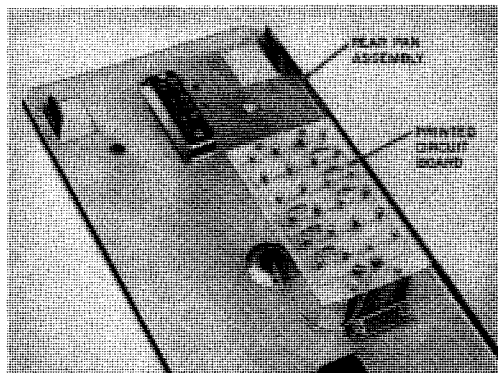

Fig. 16—Printed Circuit Board (Part of D-180941 Kit of Parts) Mounted to Rear Pan Assembly of 10A Coinless Telephone Set

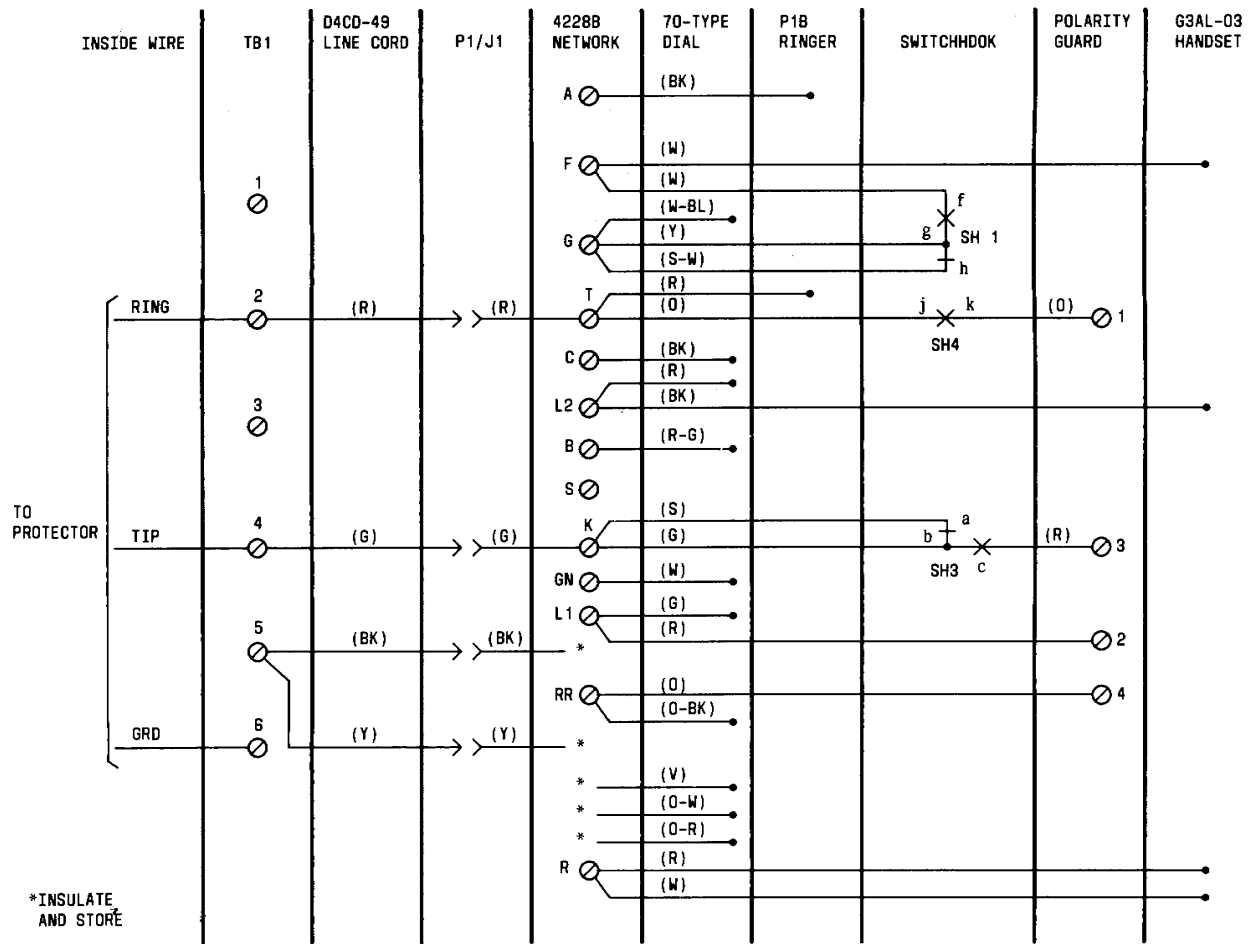

Fig. 17—10A and 20A Coinless Telephone Set, Connections