

REFERENCE

INDUCTIVE NOISE

1. GENERAL

1.01 This section contains information to control and minimize the effects of inductive noise at a subscriber station.

1.02 This section is reissued to:

- Add Fig. 2 and 3
- Revise Table B
- Change ringer isolator and telephone set connections Fig. 6 and 7
- Add note on P1A ringer, Fig. 4, 5, 8, and 9.

1.03 Inductive noise, as used in this section, is caused by telephone station being within the electromagnetic field of:

- Power circuits
- Transformers
- Neon lights
- Fluorescent lights
- Office machines.

Such fields create foreign voltages on the telephone circuit. Unbalance of the telephone circuit will result in noise and low frequency hum.



Station apparatus and associated wiring should not be located closer to possible sources of inductive noise than the separations specified in Division 461 sections covering wiring and clearances.

2. CONTROL OF INDUCTIVE NOISE

2.01 Poor insulation or resistance unbalance of the telephone circuit contributes to noise resulting from inductive interference. Locating

and eliminating the cause of high leakage or resistance unbalance may adequately solve the problem.

2.02 The balance-to-ground of the customer station sets is often the controlling factor in the susceptibility to inductive noise.

Note: The unbalance between the two sides of a line which has only the capacitance afforded by the air dielectric between the tip and ring shall not exceed three volts on the meter at the local testdesk.

2.03 The unbalances due to nongrounded ringers are small and noise resulting from the action of induced voltages on these unbalances is usually negligible.

2.04 When noise is encountered, the steps required for the control of inductive noise (in order of practical application) are:

- (1) Balance line.
- (2) Install 3-element tube.
- (3) Install 4-element tube.
- (4) Install solid state ringer isolator.

2.05 ♦The 425A and 426A electron tubes are compatible and can be mixed with no adverse effects on the circuit.♦

3. STATION RINGING BRIDGES

3.01 B-type ringers, which are manufactured with magnetic iron core ringer coils, have red-stripped markings on both coil covers. These red-stripped ringers are lower in impedance and increase the susceptibility to inductive noise when used for grounded ringing.

3.02 All low-impedance ringers on grounded ringing lines troubled with inductive noise

should be replaced by high-impedance capacitor-type ringing bridges i.e. C4A type or equivalent.

3.03 When inductive noise is excessive on lines with high-impedance capacitor-type grounded ringing bridges, tubes or ringer isolators may be utilized to minimize the effects of the induced voltage.

3.04 From the standpoint of susceptibility to inductive noise, a grounded station ringer equipped with a tube or ringer isolator is equivalent to a nongrounded ringer (provided the induced voltage between the line and ground is not high enough to cause conduction of the tube, or exceed the limits of the ringer isolator, and that tip party identification is not used).

4. MULTISLOT COIN STATIONS

4.01 Multislot coin first coin collectors are susceptible to inductive noise in exposed areas. Older types of coin first coin collectors have a large shunt unbalance caused by the connection of the coin relay from one side of the line to ground. Later types correct this unbalance by use of center-tapped 101B induction coils of 425- or 4010-type networks with the coin relay connected from the center tap (balance point) to ground.

4.02 Where noise problems arise with older type coin collectors, it will be necessary to replace the coin collector with one employing a 425- or 4010-type network.



The single slot coin telephone sets are much less susceptible to inductive noise and should be used in place of multislot coin collectors since they use a ground-lifting relay (in DTF systems) to effectively reduce inductive interference.

4.03 The electromagnet associated with 10-cent operation is connected in series with the line. In order to minimize the effect of the electromagnet on transmission, a 452A or 452B 4-uf capacitor is connected in parallel with it. In areas of low-frequency inductive interference it may be necessary to increase the size of this capacitor to keep the noise pickup within acceptable limits. A D-180327 Kit of Parts (Fig. 1) is available for this purpose and is intended for use in all 200-type coin collectors using a 425- or 4010-type network. It replaces the 452A or 452B capacitor.

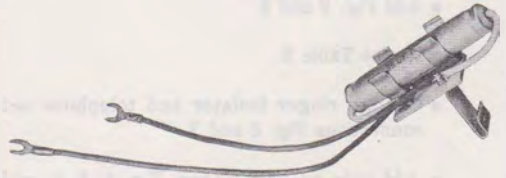

Fig. 1—D-180327 Kit of Parts

4.04 The D-180327 Kit of Parts will not fit in the 3-slot panel, 235- and 1235-type coin collectors.

5. DEVICES TO MINIMIZE INDUCTIVE NOISE

5.01 Three different electrical devices may be used to minimize the effect of inductive noise where encountered.

- 426-type, 3-element, gas-filled cold cathode electron tube

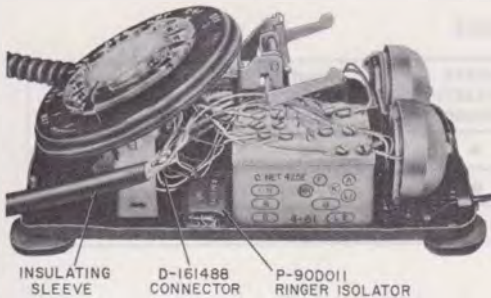

Fig. 2—Ringer Isolator in 500-Type Telephone Set

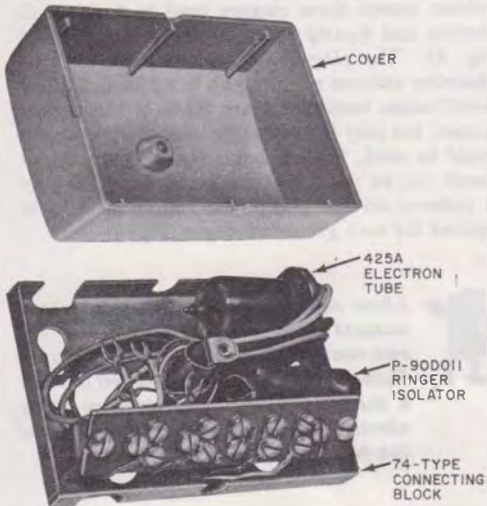

Fig. 3—Ringer Isolator in 74-Type Connecting Block

- 425-type, 4-element, gas-filled cold cathode electron tube
- Ringer isolator (D-180036 Kit of Parts)

5.02 Table A shows usage of the tubes, ringer isolator for the various party services.

5.03 Tube equipped sets usually require either superimposed ringing (ac ringing voltage plus a dc bias voltage), or a pulsating ringing current, in order to assure satisfactory ringer operation. If a suitable supply is not available, tube equipped sets cannot be used.

5.04 The limitations on the number of tube equipped ringing bridges and the permissible loop resistance are more restricted than for regular capacitor-type ringing bridges. The reduction in limitations is different for various central office ringing arrangements. For the limitations, refer to Section 500-114-100.

5.05 Tube equipped sets may be used on 2-party lines provided tip-party identification is not required.

3-Element Tube (426-Type)

5.06 The 426-type 3-element tube may be added to high-impedance grounded ringers to minimize the effects of inductive noise where encountered.

5.07 When 3-element tubes are used to combat inductive interference, station ringers should be connected as shown in Fig. 4.

5.08 For positive stations on lines experiencing inductive interference, inducted noise voltages of 20 to 30 volts may be sufficient to cause the control gap to conduct. This conduction ("flashover") will result in noise (sputtering) on the line during conversation.

5.09 At negative station, the (R) tube lead is normally connected to tip to put the control

TABLE A
PARTY SERVICES

DEVICE	2-PARTY	4-PARTY FULL SELECTIVE RINGING	4-PARTY SEMISELECTIVE RINGING	8-PARTY SEMISELECTIVE RINGING	2-PARTY WITH TIP PARTY IDENTIFICATION
3-Element Tube	•	•	•	•	
4-Element Tube	•	•	•	•	
Ringer Isolator	•		•		•

gap across the line. At stations without ANI the (R) lead may be connected to ground if ringer operation is marginal. Where negative stations are connected to 96-volt long line circuits, the (R) lead must be connected to ground. The main gap will normally withstand 70 to 80 volts of induced noise before "flashover" (conduction).

5.10 For additional information on the 3-element tube, see Section 501-320-100.

4-Element Tube (425-Type)

5.11 The 425-type 4-element tube may be required in cases where the induced voltage on the telephone line exceeds the values for satisfactory operation of the 3-element tube.

5.12 The control gap of the 4-element tube is bridged across the line (and the main gap connected between the line and ground) for both positive and negative stations (Fig. 5). The line is protected from induced noise by the high breakdown point of the main gap.

Note: When a station set is equipped with a 425A tube and used with 96-volt dial long line circuit, install a 542K .5uf capacitor (furnished locally) in series with the (G) tube lead using any spare terminal or D-161488 connector.

5.13 For additional information on the 4-element tube see Section 501-320-100.

Ringer Isolator (D-180036 Kit of Parts)

5.14 The P-90D011 ringer isolator (furnished with kit) may be used in those cases where the central office is not equipped to provide superimposed

ringing (5.03) or in grounded ringing arrangements with 96-volt long line circuits where a tube is not required.

5.15 The ringer isolator is intended for use with all grounded ringers where there is a noise problem except those ringers used in 4-party full selective and 8-party semiselective ringing service (Fig. 6). The ringer isolator may be used at subscriber stations requiring tip party identification. Identification connections are made in the normal manner, but only the 2650-ohm identification circuit should be used. The 1000-ohm identification circuit should not be used because excessive noise may be induced on the line. One ringer isolator is required for each grounded ringer (Fig. 7).



Lines equipped with ringer isolators cannot be tested for continuity by conventional testdesk procedures. This device should be installed in such a manner as not to interfere with electrical or mechanical operation of the telephone set (Fig. 2 and 3).

5.16 When the design of the telephone set prohibits mounting either a cold-cathode tube or a ringer isolator, inside the telephone set, use a 74-type connecting block in conjunction with the telephone set for housing either of these devices (refer to Section 461-606-100). Fig. 8 shows AC1 or AD1 telephone base connections using 74A connecting block.

5.17 Table B and (Fig. 9) show wiring changes and connections for ringer isolator when used with a AC1 or AD1 telephone base.

5.18 For additional information on the D-180036 Kit of Parts (ringer isolator) see Section 501-375-100.

tubes and ringer isolator, the problem must be referred to the proper supervision for other corrective arrangements.

5.19 If situations are encountered where induced voltage exceeds the capabilities of the electron

◆ TABLE B ◆
MODIFICATION AND CONNECTIONS OF AC1 AND AD1 TRIMLINE®
BASE FOR RINGER ISOLATOR (FIG. 9)

WIRE OR LEAD	COLOR	REMOVE FROM		CONNECT TO TERM. BOARD	CONNECT TO 74-TYPE CONN BLK
		AC1	AD1		
Ringer	BK	L1	G	3	
	S	B	B	Note 3	
Strap	Y		G	A	
Line Switch	S	A	A	*	
Mtg Cord AD1 Base	R				4
	G				5
	Y				2
	BK				3
	W				1
Inside Wire AC1 Base	R			L2 ← →	4
	G			L1 ← →	5
	Y			A ← →	2
	BK			1 ← →	3
	R†			3 ← →	1
Ringer Isolator	R				4
	G				5
	Y				1
	BK				2
Line Wire	Ring	R			4
	Tip	G			5
	Grd	Y			1
	BATT	BK			3

* Insulate and store.

† First conductor of second inside wire (quad).

- Notes:**
1. Connections are for tip party reverse tip and ring line wire leads for ring party.
 2. Use 74-type connecting block for housing ringer isolator and terminating mounting cord or inside wire, disconnect and store 425A electron tube leads.
 3. Connect to terminal B for tip party identification if current model P1A ringers are used.

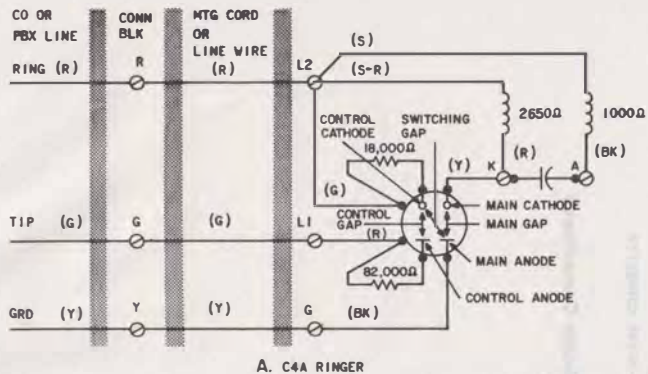

NEGATIVE RING STATION
425A ELECTRON TUBE (NOTES 1 AND 2)

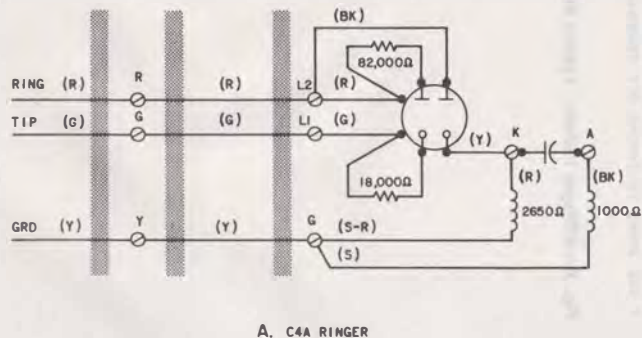
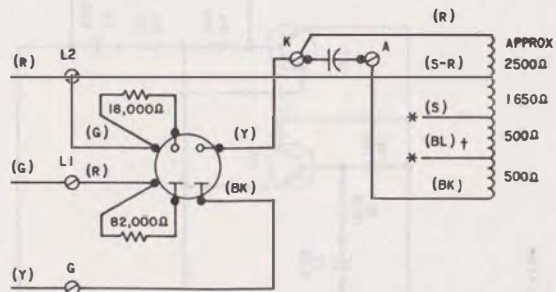

POSITIVE RING STATION
425A ELECTRON TUBE (NOTES 1 AND 2)

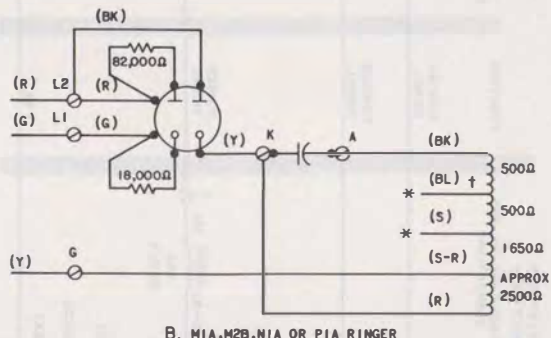

NOTES:

1. WHEN A STATION SET IS EQUIPPED WITH A 4-ELEMENT 425A ELECTRON TUBE AND USED WITH 96 VOLT DIAL LONG LINE CIRCUIT, INSTALL A 542K CAPACITOR .5UF (FURNISHED LOCALLY) IN SERIES WITH THE (G) TUBE LEAD USING ANY SPARE TERMINAL OR D-161488 CONNECTOR.

2. FOR TIP STATION, REVERSE TIP AND RING LEADS AT CONNECTING BLK (OR EQUIVALENT)

* INSULATE AND STORE

† (BL) LEAD REMOVED FROM LATER MODEL P1A RINGERS.

Fig. 5 — 4-Element Tube, Typical Ringing Bridge Connections

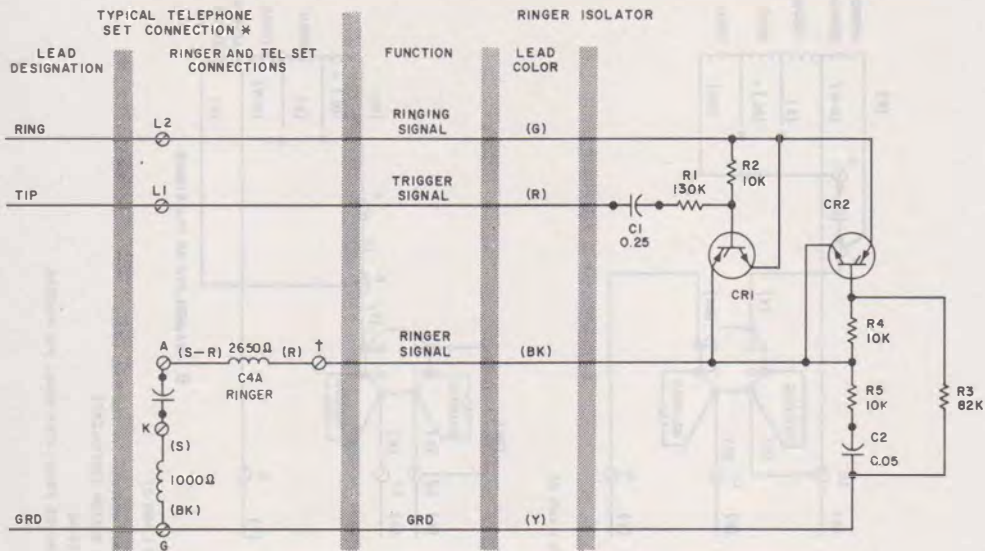

* RING STATION FOR TIP STATION REVERSE TIP AND RING LEADS AT CONNECTING BLOCK (OR EQUIVALENT).

† USE SPARE TELEPHONE SET TERMINAL OR D-161488 CONNECTOR.

Fig. 6 — Ringer Isolator, Typical Ringing Bridge Connections

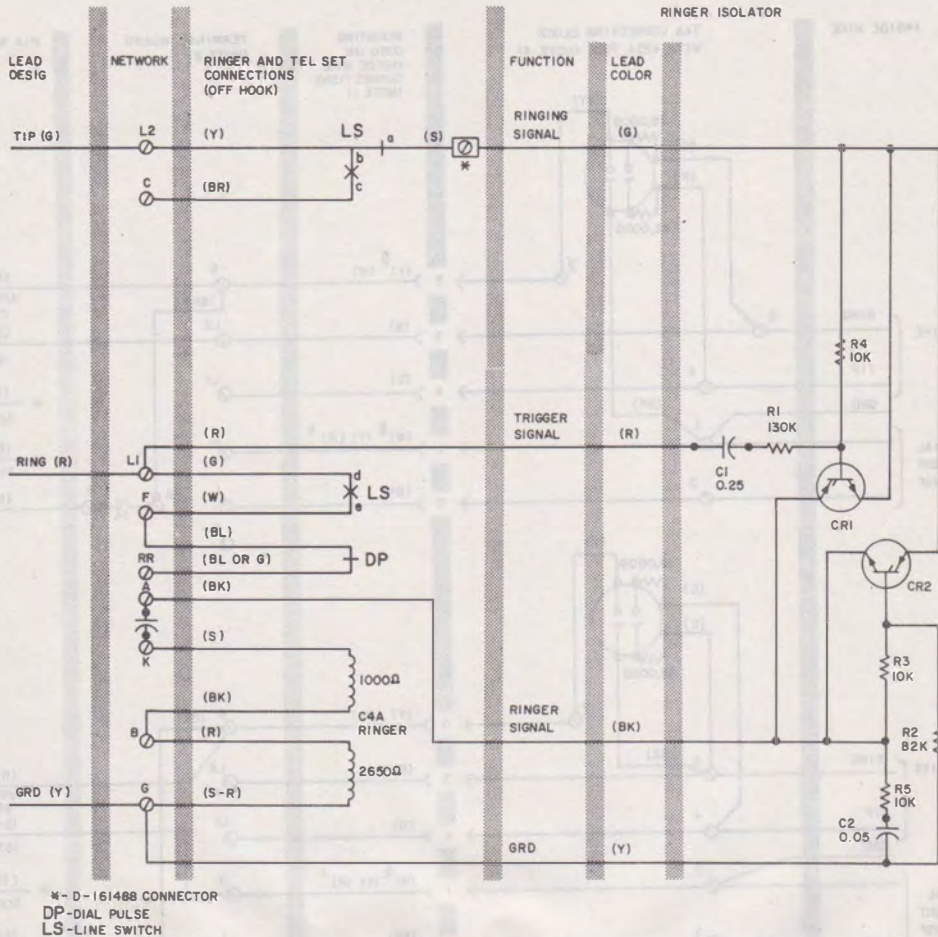
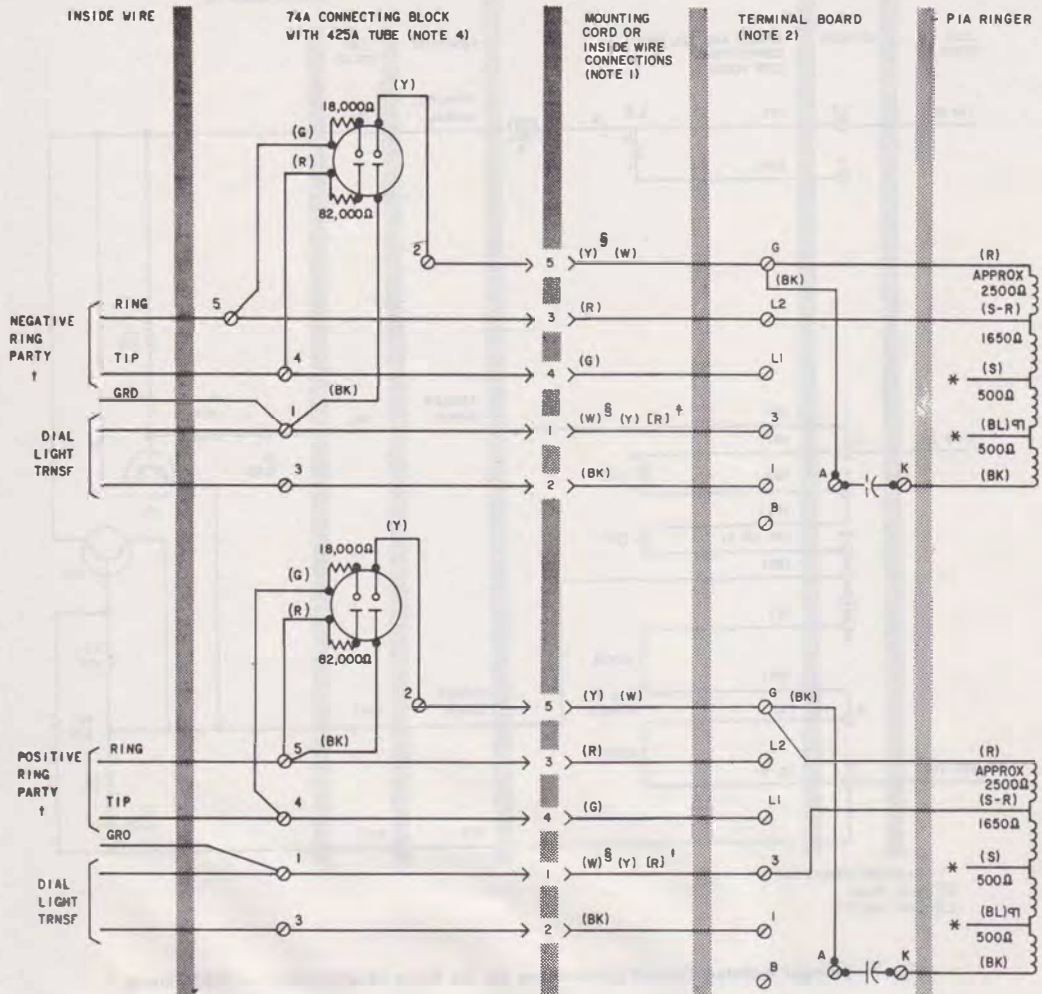

Fig. 7 - Ringer Isolator, Typical Connections for Tip Party Identification - 2650 Ohms



- () - MOUNTING CORD CONDUCTORS
- [] - INSIDE WIRE CONDUCTORS
- * - INSULATE AND STORE
- † - FOR TIP STATION-REVERSE RING AND TIP LEADS AT 74A CONNECTING BLOCK.
- ‡ - [R] CONDUCTOR OF SECOND QUAD INSIDE WIRE
- § - BASES MANUFACTURED PRIOR TO 10/1/72
- ¶ - (BL) LEAD NOT PROVIDED ON CURRENT PRODUCTION MODELS

NOTES:

1. FIVE CONDUCTORS REQUIRED BETWEEN 74A CONNECTING BLOCK AND TELEPHONE SET. USE ONE QUAD AND PAIRED OR TWO TRIPLES WITH ACI BASE.
2. DISCONNECT (S) LINE SWITCH LEAD FROM A OF TERMINAL BOARD, INSULATE AND STORE.
3. TIP PARTY IDENTIFICATIONS CANNOT BE FURNISHED WITH THESE CONNECTIONS.
4. WHEN A STATION SET IS EQUIPPED WITH A 4-ELEMENT 425A ELECTRON TUBE AND USED WITH 96 VOLT DIAL LONG LINE CIRCUIT, INSTALL A 542K CAPACITOR .5UF (FURNISHED LOCALLY) IN SERIES WITH THE (G) TUBE LEAD USING ANY SPARE TERMINAL OR D-161488 CONNECTOR.

Fig. 8—74A Connecting Block and Ringer Circuit in AC1 and AD1 Telephone Bases—Connections for Extreme Inductance Interference

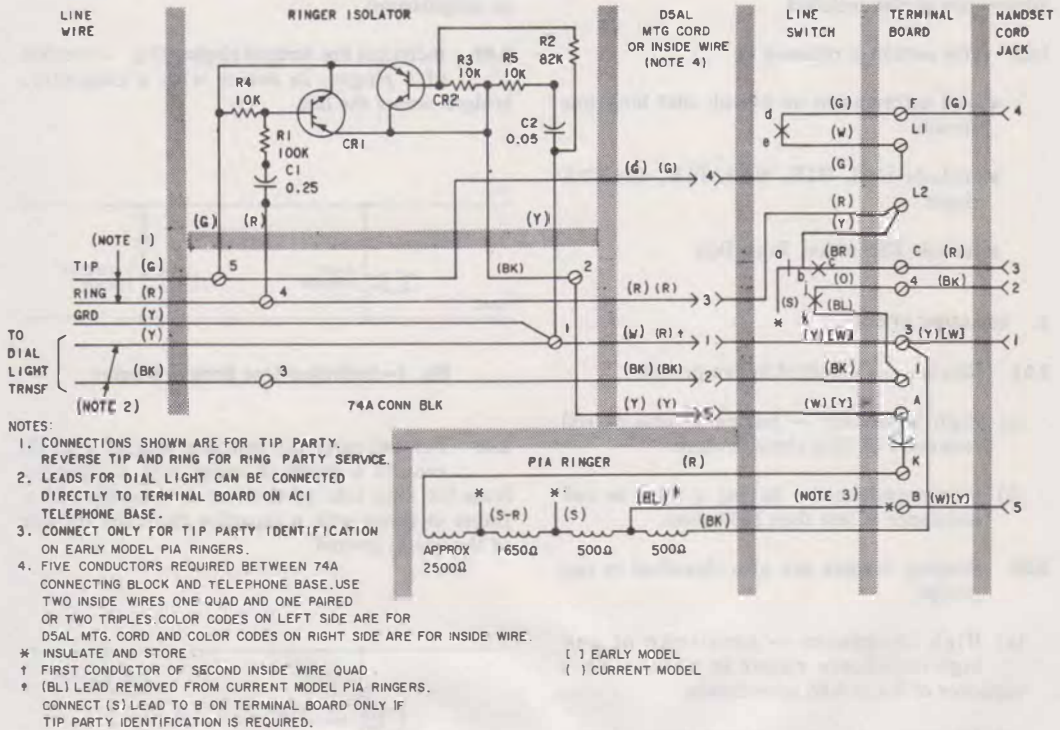

Fig. 9—74A Connecting Block and Ringer Isolator Connections with ACI or ADI Telephone Bases