

831- AND 2831-TYPE TELEPHONE SETS

IDENTIFICATION, INSTALLATION, MAINTENANCE, AND CONNECTIONS

1. GENERAL

- 1.01 This section contains information for the 831- and 2831-type telephone sets.
- 1.02 This section is reissued to:
- Show 831DM and 2831DM telephone set MD
 - Show G12A handset (A&M Only)
 - Show 3-type speakerphone MD
 - Show 533K diode for use with Station Busy Lamp, and Dial Restriction
 - Add information on 831FM and 2831FM telephone sets
 - Add Table A, ordering guide and replaceable components
 - Remove information on P-90D170 polarity guard
 - Remove information on D-180656 Kit of Parts (wall mounting arrangement)

Since this reissue covers a general revision, arrows ordinarily use to indicate changes have been omitted.

2. IDENTIFICATION

A. Purpose

- 2.01 The 831- (Rotary dial) and 2831- (TOUCH-TONE® dial, Fig. 1) type telephone sets are obtainable as modular or complete desk-type, 20-button, key telephone sets equipped to provide standard key system features. Refer to Table A for available colors.



Fig. 1—2831DM (MD) or 2831FM Telephone Set

B. Application

- 2.02 Used with central office, PBX or intercommunication line circuits in 1A1, 1A2, or 6A key telephone system (KTS). These sets are not equipped for use with 1A KTS.
- 2.03 All 831- and 2831-type telephone sets may be used with the 3-type (MD) or 4A speakerphone system. When used with 3-type speakerphone, a D10R auxiliary mounting cord may be required due to the limited number of mounting cord conductors.

C. Optional Components

- 2.04 *Optional Components (order separately):*
- Diode, 533K (for use with station busy lamp)

NOTICE

Not for use or disclosure outside the Bell System except under written agreement

- Diode, 533K for dial restriction (831-type sets only)
- Buzzer, KS-8109L2
- Buzzer, KS-20419L1 (one provided with set)
- 819041971 (P-90D197) adhesive backed Polarity Guard, 2831-type
- Lamp, 51A (hold button for message waiting)
- Dial, 8CA-58 (for 831-type set used with speakerphone).

D. Ordering Guide

2.05 For telephone set, faceplate, and replaceable components ordering guide, refer to Tables A and B.

E. Design Features

2.06 Design features for the 831- and 2831-type sets are as follows:

- Modular set
- 20-button; a HOLD button and 19 pickup buttons (all telephone sets except the [831DM (MD), 831FM, 2831DM (MD), and 2831FM], all pickup buttons are convertible to signaling
- 20-button; a HOLD button, 15 pickup, 3 intercom, and 1 RECALL button [831DM (MD), 831FM, 2831DM (MD), and 2831FM

only], all intercom and pickup buttons are convertible to signaling

- Automatic Button Restoration (ABR) with preselect [831DM (MD), 831FM, 2831DM (MD), and 2831FM] telephone set only
- Multiline Conferencing (MLC) 831DM (MD), 831FM, 2831DM (MD), and 2831FM telephone sets only, on pickup lines only (no conferencing on intercom lines or pickup-to-intercom lines)
- Hold button can be illuminated (lamp ordered separately)
- KS-20419L1 buzzer provided and connected to dedicated mounting cord leads
- Provisions for mounting KS-8109L2 buzzer or additional KS-20419L1 buzzer(s) on base pan
- Provision for polarity guard assembly (optional) on all 2831-type telephone sets except 2831DM or 2831FM sets
- Plug-in handset [G12A (A&M Only) or G15A]
- An access hole is provided in the P1-type ringer for ringer biasing spring adjustment (refer to Section 501-259-101)
- Limited number of mounting cord conductors restricts number of optional features which may be simultaneously provided. If additional

TABLE A

TELEPHONE SETS ORDERING GUIDE AND REPLACEABLE COMPONENTS

TEL SET	BASE	HOUSING	DIAL	KEY	FACE-PLATE	HANDSET	HANDSET CORD	LAMP
831CM	831CM	832A-*	8RA-58	647A5C 647B5	833A-*	G15A-*	H4DU-*	51A
831FM	831FM	832A-*	8RA-58	647AH5, 647AL5C	833A-*	G15A-*	H4DU-*	51A
2831CM	2831CM	832A-*	35AF3A	647A5C, 647B5	2833A-*	G15A-*	H4DU-*	51A
2831FM	2831FM	832A-*	35AF3A	647AH5, 647AL5C	2833A-*	G15A-*	H4DU-*	51A

* See Table B for color suffix.

TABLE B
COLOR ORDERING GUIDE

HOUSING, HANDSET, AND HANDSET CORD		FACEPLATE	
COLOR	SUFFIX	COORDINATED COLOR	SUFFIX
Black	-03	Charcoal	-70
Ivory	-50	Muted Ivory	-80
Green	-51	Light Green	-71
Red	-53	Muted Red	-69
Yellow	-56	Light Yellow	-72
White	-58	Light Gray	-73
Light Beige	-60	Muted Beige	-75
Aqua Blue	-62	Muted Blue	-76

conductors are required, an auxiliary D10R cord may be used

- 3-type (MD) or 4A speakerphone (paragraph 2.03)
- Tip and ring are common to all pickup buttons through internal mounting cord wiring (current sets) and control strips (early sets).

F. Operating Features

2.07 The operating features for the 831- and 2831-type telephone sets are the same as all standard key type telephone sets with the following exception. The 831DM (MD), 831FM, 2831DM (MD), and 2831FM telephone sets provide the following additional features.

- (a) **Multiline Conferencing:** Any combination of pickup buttons may be simultaneously depressed, for this feature, however, it is not possible to conference CO/PBX lines with the dedicated intercom lines or intercom lines with each other.



When lines are conferenced, distant stations may have difficulty hearing each other and transmission quality is not guaranteed.

- (b) **Automatic Button Restoration (ABR):** The ABR feature releases locked-down buttons when the handset is restored. The buttons may

be preset without removing the handset from the cradle.

- (c) **Line Recall:** An amber-capped recall button is provided to simulate switchhook flash without releasing the buttons. This button is located on the left end of the top 10-button key.

- (d) **Intercom:** Three buttons are dedicated to the intercom feature. These buttons are located on the right end of the lower 10-button key and may be converted in the standard manner to provide signaling or may be used for CO/PBX lines. However, CO/PBX lines when terminated at these positions will not be conferenceable.

3. INSTALLATION

3.01 Install the completely assembled telephone set or assemble the required components to the telephone set base (Fig. 2).

Note: On current production keys the cap must be properly oriented to lock the cap on the button.

3.02 Individual signaling may be provided by converting a locking key button to nonlocking. Remove the 812857738 (P-28E773) locking pin from the button to be converted and modify per Table C.

3.03 If an additional buzzer is required, plastic screw grommets and mounting screws are provided for installation. The additional KS-8109L2 or KS-20419L1 buzzer must be ordered separately.

3.04 Dial Restriction.

(1) 831-Type Telephone Set.

- (a) Install a 533K diode between terminals RR and F of the network as shown in Fig. 4.

(b) Wire telephone set as shown in Table E.

(2) 2831-Type Telephone Set: Wire telephone set as shown in Table E.

(3) Installations as described above will restrict dialing on all lines of the respective telephone

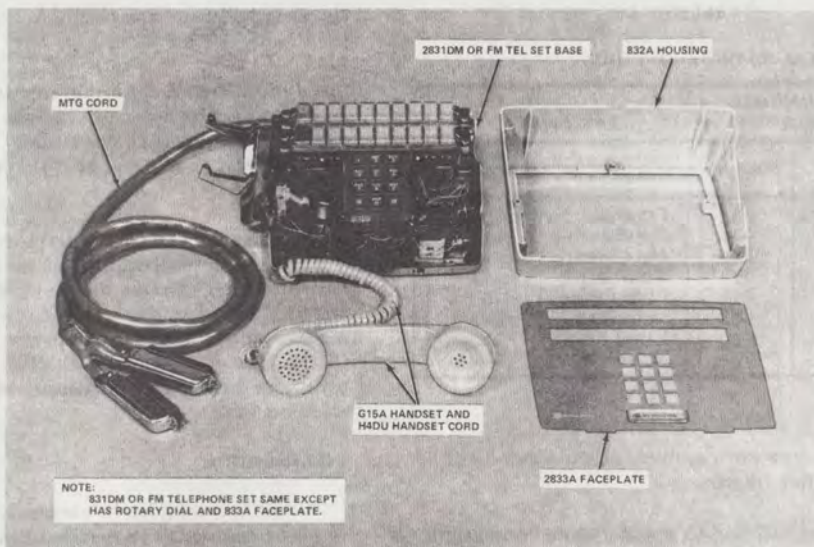

Fig. 2—Station Modular Arrangement, 2831DM (MD) or 2831FM Telephone Set

set. To permit dialing on selective lines, reverse tip and ring leads of the line involved at the distribution terminal or 66-type connecting block. When a 2A1 matrix block is used, the reversing of conductors must be done on the telephone set side of the matrix block.

(4) For additional restriction information, refer to Section 500-155-100.

3.05 Polarity guard (2831-type except the 2831DM and 2831FM; see paragraph 3.06) should be used only when specified by local instructions for end-to-end signaling installations where battery and ground reversals may be encountered. An 819041971 (P-90D197) polarity guard assembly (adhesive backed) is installed wherever space permits. Connect per Table F.

3.06 The 831DM, 831FM, 2831DM, and 2831FM telephone set employs the 2A1 matrix block in lieu of the polarity guard described in paragraph 3.05. The unit provides eight polarity guard circuits. One polarity guard circuit is required for each line which is conferenceable by multibutton depression. The polarity guard is located between the station

side of the line circuit and the station cut-down field.

3.07 Where conditions warrant, G3A6, G12A, or G15A handset can be replaced with other types as follows:

- For impaired hearing — G6-type
- For weak speech — G7-type
- For noisy location—G8-type.

Refer to Division 501 for connections of these handsets. When either of these handsets are used, an H4DU or H4CJ or equivalent handset cord must be used (see paragraph 3.08).

3.08 *Installing Spade-Tipped Handset Cords in Early Production Sets Equipped with G12A Handset:* To install spade-tipped handset cord (H4CJ or equivalent) remove J Hook Stayband from the cord. Cut back and remove cord sheath to stayband marks. Thread spade-tipped conductors through plug (Fig. 3) (spade tips must be bent to clear cord entrance). Pull cord until about 1/4-inch of cord sheath is in the central

cavity of the plug. Separate the conductors into two groups and tie an overhand knot, pulling the knot to the cord sheath. Pull the cord from plug until strain relief position is attained by knot entering sheath and resting against plug. Feed spade-tipped conductor straight through jack 812266203 (P-22F620) and connect to proper terminals. Insert plug in jack.

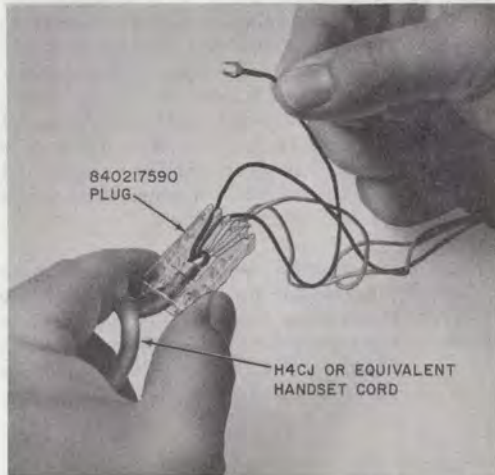

Fig. 3—Installing Spade-Tipped Handset Cord Leads

Note: On later version of the telephone set base, a plug is not required and a notch is provided on front lip of base pan for J Hook Stayband of nonmodular type cords.

3.09 When adding speakerphone to 831-type telephone sets, the 8RA dial must be replaced by an 8CA dial (order separately) to provide the additional off-normal contacts required for speakerphone connections.

3.10 When using speakerphone with telephone sets equipped with the new line switch assembly, make wiring changes shown in Table I. The new line switch can be identified by two additional leads which are Blue (BL).

3.11 The 831FM and 2831FM telephone sets may be used in all cases to directly replace the 831DM (MD) 2831DM (MD) telephone sets, respectively.

However, due to wiring changes, the DM codes can not always be used to replace the FM codes.

4. MAINTENANCE

4.01 Maintenance of the 831- and 2831-type telephone set should be limited to checking for loose or broken connections and replacement of items per local instructions.

4.02 Early manufactured cords in neutral light pearl-gray (-82) and dark gray-brown (-83) are rated MD. All new mounting cords will be satin-silver (-87).

4.03 Current sets are equipped with a P1B ringer which does not have the (S-R), (S), (BL) leads. For maintenance purposes, either the P1B or P1A ringer may be used. (If P1A ringer is provided, insulate and store the unused leads.)

4.04 For maintenance of keys, buzzers, dials, speakerphone components, and polarity guard, refer to appropriate sections pertaining to these items.

4.05 The current production 647-type keys have been modified for easy lamp replacement by merely removing the button cap and inserting a 553-type tool through the hole in the top of the button. In early production models it is necessary to remove faceplate, key collar, and button for lamp replacement.

Note: When installing or replacing the 647-type key for maintenance in the 831- and 2831-type key telephone set, the 812857704 (P-28E770) latch bar spring must be removed to prevent mechanical stress on the latch bar to pivot bar action. For information on removal procedures, refer to Section 512-230-101.



Telephone sets should NOT be carried by the handset cradle. Line switch failure may be caused by applying excessive strain to the handset cradle and the line switch mounting arrangement.

5. CONNECTIONS



Due to the limited number of mounting cord conductors the telephone sets do not follow standard wiring

arrangements (Fig. 5 through 14).

- 5.01** To provide mounting cord lead for illuminating the HOLD button the ringer or buzzer leads must be used, meaning, only two of the three options (ringer, buzzer, or hold lamp) may be provided at the same time.
- 5.02** To provide station busy lamp, modify the telephone set wiring and connect the 533K diode (ordered separately) per Table G.
- 5.03** To provide priority hold (I HOLD) modify the telephone set per Table H.
- 5.04** To provide 3-type (MD) speakerphone leads in the mounting cord, the buzzer leads along with the lamp and lamp ground leads from the last two pickup buttons of the key must be used. An auxiliary D10R cord may be used if these leads are not available. Refer to Section 512-620-485 for connections and Table J.
- 5.05** To provide 4A speakerphone connections refer to Section 512-740-470 and Table J.
- 5.06** To provide polarity guard for all 2831-type telephone sets except the 2831DM and 2831FM refer to Table F. The 2A1 matrix block is used as a polarity guard for the 2831DM and 2831FM telephone sets (see paragraph 5.08).
- 5.07** For schematic information, refer to Fig. 5 through 14.
- 5.08** The 2A1 matrix block (ordered separately) provides the polarity guard function to telephone set with multiline conferencing via multibutton depression. The matrix block consists of a 66-type molded plastic connecting block, containing quick-connect terminals wired and equipped with eight diode bridges for eight lines. The matrix block is connected between the line circuit and the station cut-down field. For connections to the 2A1 matrix block, refer to Table I.



If a station requires line ringing on a particular line, connect the ringing leads from the key telephone set to the appropriate terminals on the LINE SIDE of the matrix block, not to the station side.

TABLE C

PICKUP-SIGNAL KEY CONVERSION
(ALL TELEPHONE SETS EXCEPT DM AND FM)

CONVERSION OPTION (NOTE)	647B5 KEY LEADS (UPPER KEY)									
	O-W	S-W	G-R	BL-BK	BR-BK	BK-BR	BK-BL	R-G	W-S	V-BR
PPPPPPPPP	19	19	19	23	23	23	26	26	26	26
PPPPPPPPS	19	19	19	23	23	23	26	26	26	27
PPPPPPPSS	19	19	19	23	23	23	26	26	27	27
PPPPPPSSS	19	19	19	23	23	23	26	27	27	27
PPPPSSSSS	19	19	19	23	23	23	27	27	27	27
PPPPSSSSS	19	19	19	23	23	27	27	27	27	27

CONVERSION OPTION (NOTE)	647A5C KEY LEADS (LOWER KEY)									
	O-W	S-W	G-R	BL-BK	BR-BK	BK-BR	BK-BL	R-G	W-S	
HPPPPPPPP	7	7	7	11	11	11	15	15	15	
HPPPPPPPS	7	7	7	11	11	11	15	15	27	
HPPPPPPSS	7	7	7	11	11	11	15	27	27	
HPPPPPPSSS	7	7	7	11	11	11	27	27	27	
HPPPPSSSSS	7	7	7	11	11	27	27	27	27	
HPPPPSSSSS	7	7	7	11	27	27	27	27	27	

Note: Move (O-Y) mounting cord lead from terminal 6 12 to terminal 27. Beyond five signal conversions strap terminal 27 to 28 and move the signal leads consecutively to terminal 28. Example: (BR-BK) lead from terminal 23 to 28 then (BL-BK) lead from 23 to 28 etc.

831A1M (MD) or 2831A1M (MD) early version.

All other telephone sets except DM and FM.

♦TABLE D♦

PICKUP SIGNAL KEY CONVERSION [831DM(MD), 831FM, 2831DM(MD), OR 2831FM TELEPHONE SET]

CONVERSION OPTION (NOTE)	647AH5 KEY LEADS								
	BL	BL	BL	BL-BK	BR-BK	BK-BR	BK-BL	R-G	W-S
HPPPPPPPPP	Connected via internal mounting cord wiring and terminated on Term. 7 and can not be converted to signaling.			17	17	17	11	11	11
HPPPPPPPPS				17	17	17	11	11	27
HPPPPPPPSS				17	17	17	11	27	27
HPPPPPPSSS				17	17	17	27	27	27
HPPPPSSSSS				17	17	27	27	27	27
HPPPPSSSSS				17	27	27	27	27	27

Note: Move (O-Y) mounting cord lead from terminal 12 to terminal 27. For sixth signal conversion strap terminal 27 to a spare terminal and move the (BL-BK) signal lead from 17 to spare terminal selected.

TABLE E

DIAL RESTRICTION MODIFICATIONS (NOTE 1)

TELEPHONE SET	LEAD		REMOVE FROM		CONNECT TO	
	FUNCTION	COLOR	NET.	SET	NET.	SET
831FM and 2831FM	Line Tip	G		8		3
	Line Tip	G		8		3
	Line Ring	R		3		8
	Line Ring	R		3		8
831CM and 2831CM Mfg. 2-77 or later (Note 3)	Line Tip	G		8		6
	Line Tip	G		8		6
	Line Ring	R		6		8
	Line Ring	R		6		8
831CM and 2831CM E/W New Line Switch and Mfg. before 2-77 (Notes 2 and 3)	Line Tip	G		16		6
	Line Tip	G		16		6
	Line Ring	R		6		16
	Line Ring	R		6		16
831A1M, 831B1M, 831C, 831CT, or 831CM E/W Old Line Switch	Line Tip	G	F			6
	Line Tip	G	F			6
	Line Ring	R		6	F	
	Line Ring	R		6	F	
2831A1M, 2831B1M, 2831C, 2831CT, or 2831CM E/W Old Line Switch (Note 3)	Line Tip	G		8		6
	Line Tip	G		8		6
	Line Ring	R		6		8
	Line Ring	R		6		8

Note 1: Rotary dial telephone set must have a 533K diode (ordered separately) installed between RR and F of the network see Fig. 4.

Note 2: The new line switch can be identified by two additional leads which are (BL).

Note 3: On TOUCH-TONE sets dial restriction and polarity guard cannot be provided simultaneously.

TABLE F
POLARITY GUARD CONNECTIONS FOR 2831-TYPE
TELEPHONE SET

WIRE OR LEAD	COLOR	REMOVE FROM	CONNECT TO	
		NET.	GUARD ASSY	NET.
Dial	BK	RR	T	
	G-W	C	S	
Line Switch	W	C	S	
Guard Assembly	G			RR
	W			C

Note: For use when specified by local instructions for end-to-end signaling installations.

TABLE G
STATION BUSY LAMP CONNECTIONS

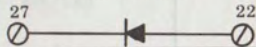
LEAD	OPERATION
Hold Key (G-W)	Remove from terminal 22 and connect to 27 or other spare terminal
533K Diode (Ordered Separately)	Connect as shown or to same spare terminal as above 
Mtg Cord (Y-O) (Note)	Remove from <input type="checkbox"/> 15 <input type="checkbox"/> 14 connect to 22

831A1M (MD) or 2831A1M (MD) early version

All other telephone sets

Note: Use spare mounting cord lead if (Y-O) lead is used to provide other options.

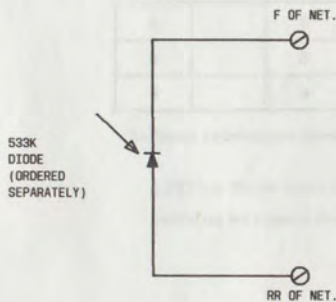

Fig. 4—Installing Diode for Dial Restriction

TABLE H
I HOLD CONNECTIONS (NOTE)

LEAD	REMOVE FROM	CONNECT TO
Hold Key	(G-W)	7
	(BK-BL)	22
SP Lead — Use (Y-O)* or spare mounting cord conductor		13

Note: For additional information see SD-69530-01

*(Y-O) lead may be used unless connected for other options

TABLE I

2A1 MATRIX BLOCK

LINE		LINE TERM. (LEFT)	STATION TERM. (RIGHT)
1	T	1	1
	R	5	5
2	T	7	7
	R	11	11
3	T	13	13
	R	17	17
4	T	19	19
	R	23	23
5	T	25	25
	R	29	29
6	T	31	31
	R	35	35
7	T	37	37
	R	41	41
8*	T	43	43
	R	47	47

*If more than 8 lines are provided, additional 2A1 matrix blocks are required.

TABLE J

3-TYPE OR 4A SPEAKERPHONE MODIFICATION FOR TELEPHONE SETS EQUIPPED WITH NEW LINE SWITCH (NOTE)

TELEPHONE SET	LEAD COLOR	REMOVE FROM TERM.	CONNECT TO TERM.
831FM, DM, CM or 2831FM, DM, CM Mfg. 2-77 or later	G	16	8
831CM Mfg. before 2-77	G	16	F
	G		
2831CM Mfg. before 2-77	G	8	16

Note: The new line switch can be identified by two additional leads which are (BL). No modification is required on sets equipped with old type line switch, [no (BL) leads].

831	DM	CM	
831	DM	CM	
831	DM	CM	
831	DM	CM	
831	DM	CM	
831	DM	CM	
831	DM	CM	
831	DM	CM	
831	DM	CM	
831	DM	CM	

TABLE J (continued) - 3-TYPE OR 4A SPEAKERPHONE MODIFICATION FOR TELEPHONE SETS EQUIPPED WITH NEW LINE SWITCH (NOTE)

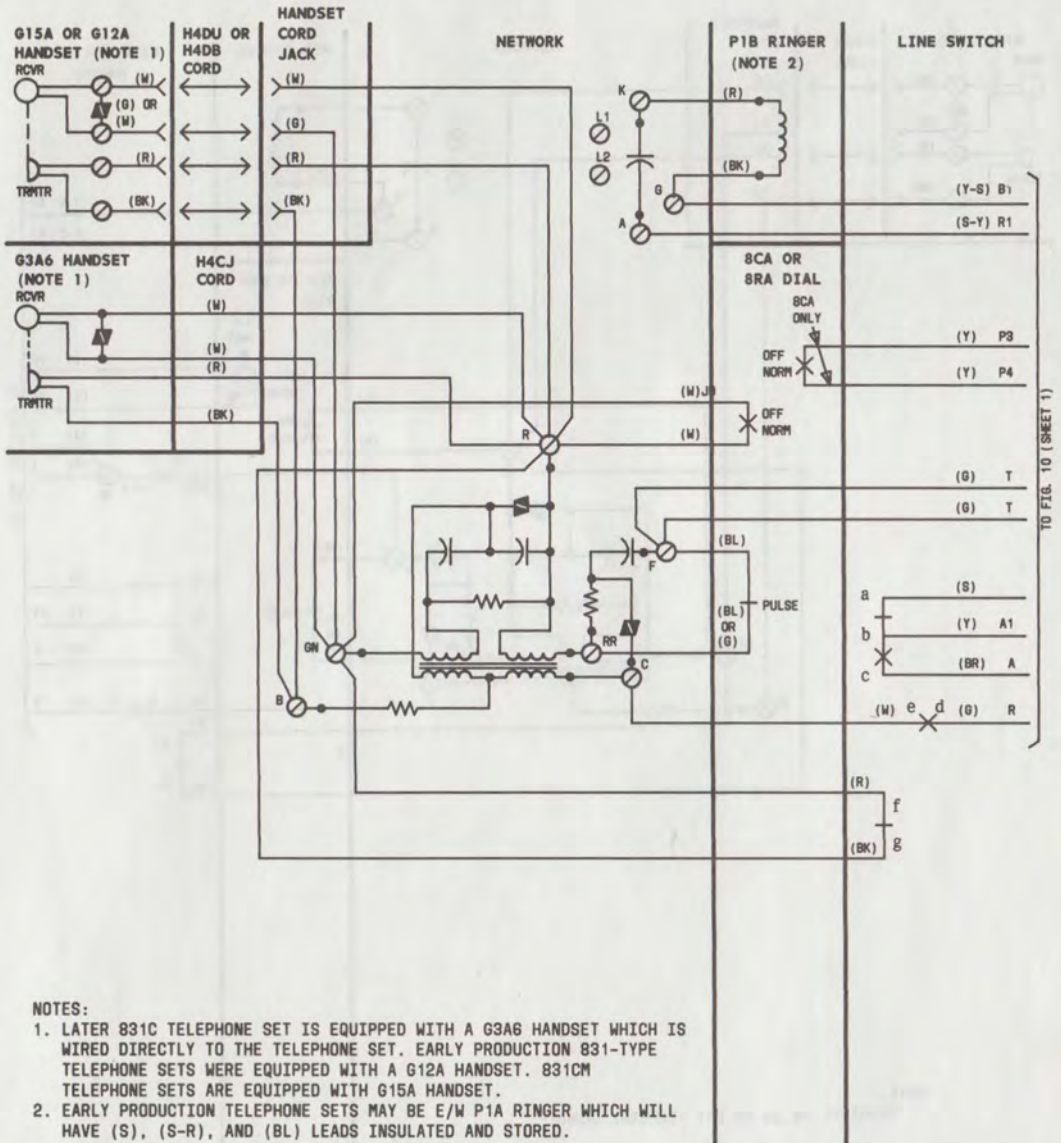
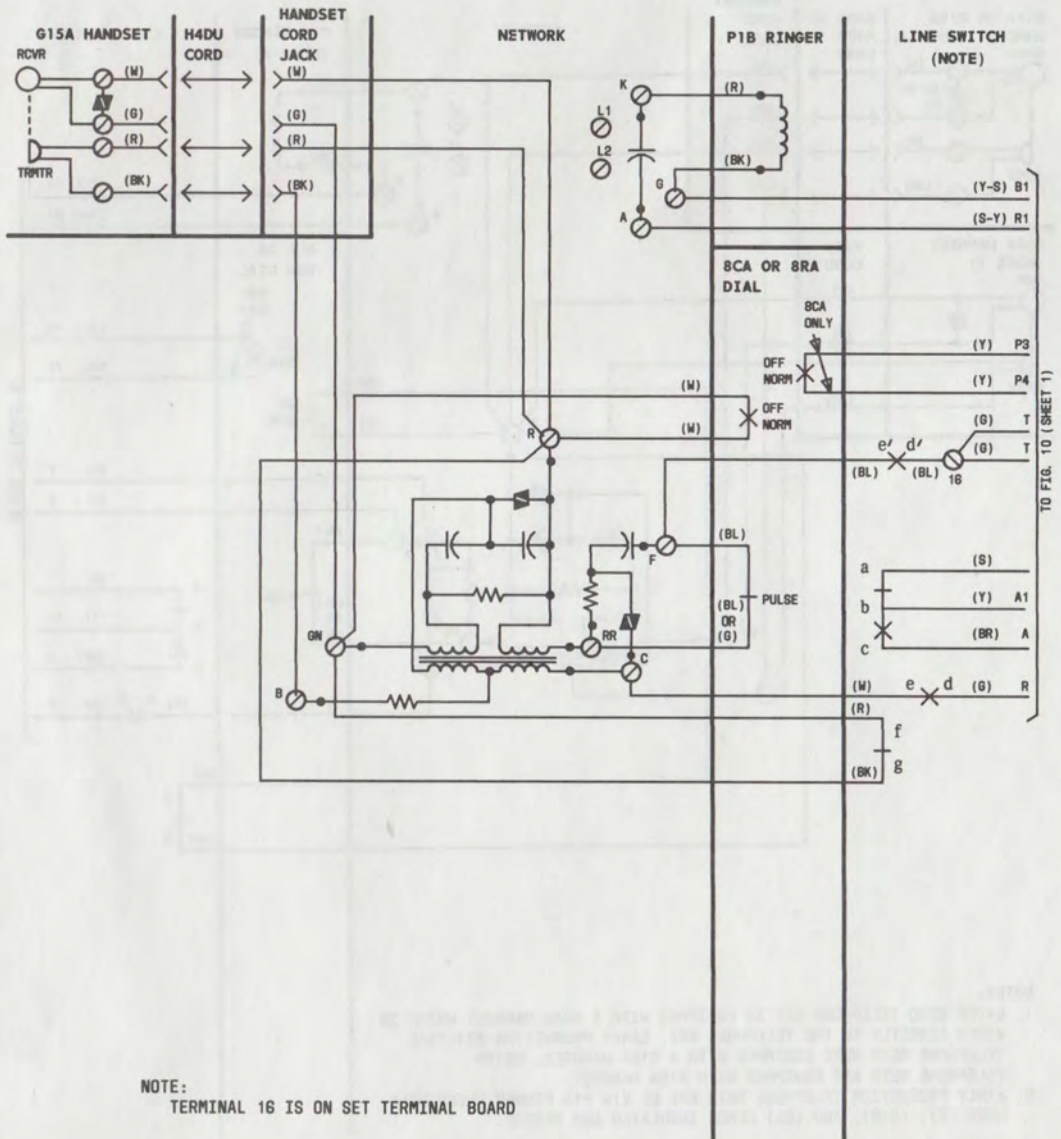
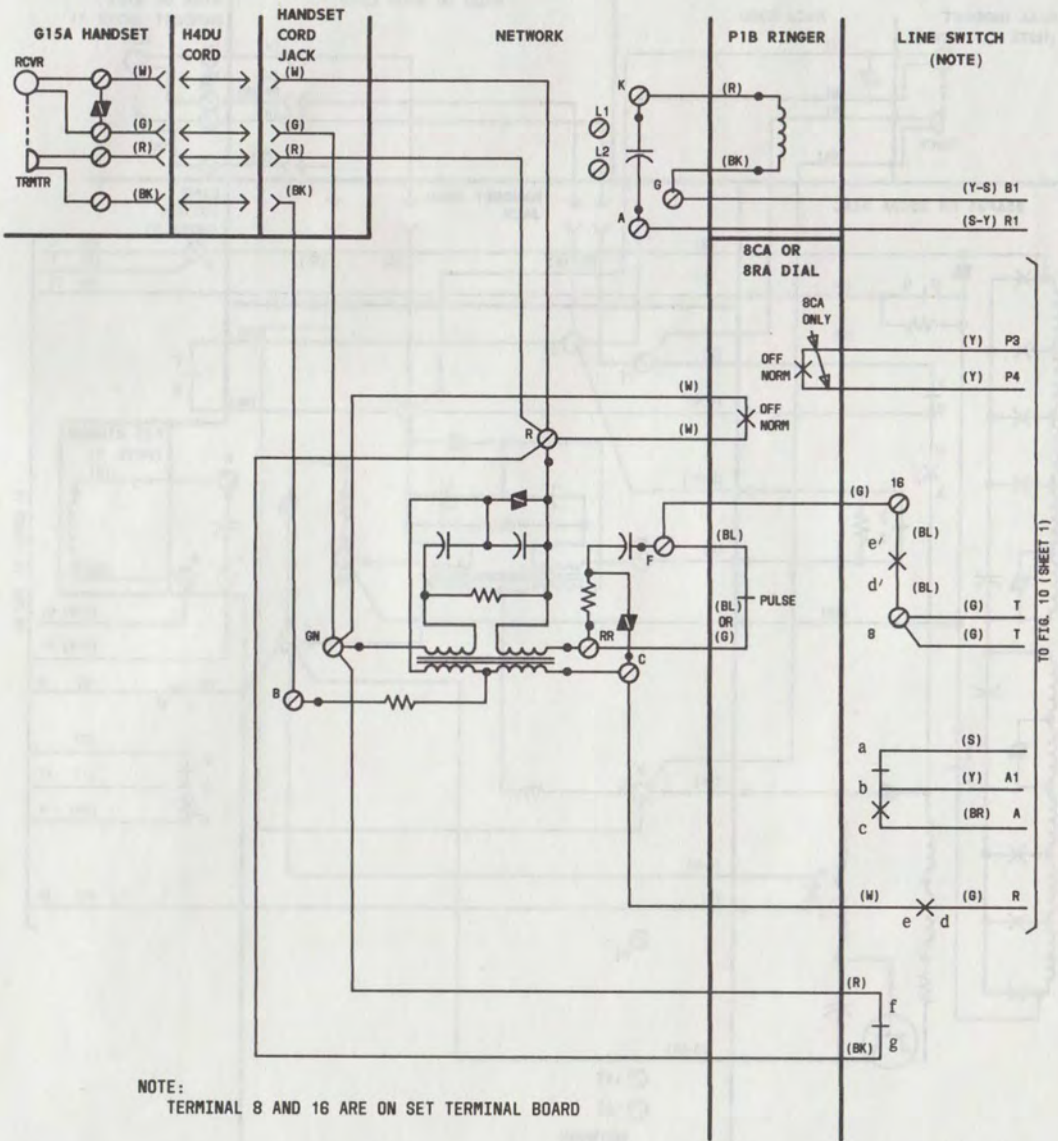

Fig. 5—Part of 831A1M (MD), B1M (MD), C (MD), CT (MD), or CM (Equipped With Old Line Switch) Telephone Set, Connections



NOTE:
TERMINAL 16 IS ON SET TERMINAL BOARD

Fig. 6—Part of 831CM (Equipped With New Line Switch and Manufactured Before 2-77) Telephone Set, Connections



NOTE:
 TERMINAL 8 AND 16 ARE ON SET TERMINAL BOARD

Fig. 7—Part of 831CM (Manufactured 2-77 or Later) Telephone Set, Connections

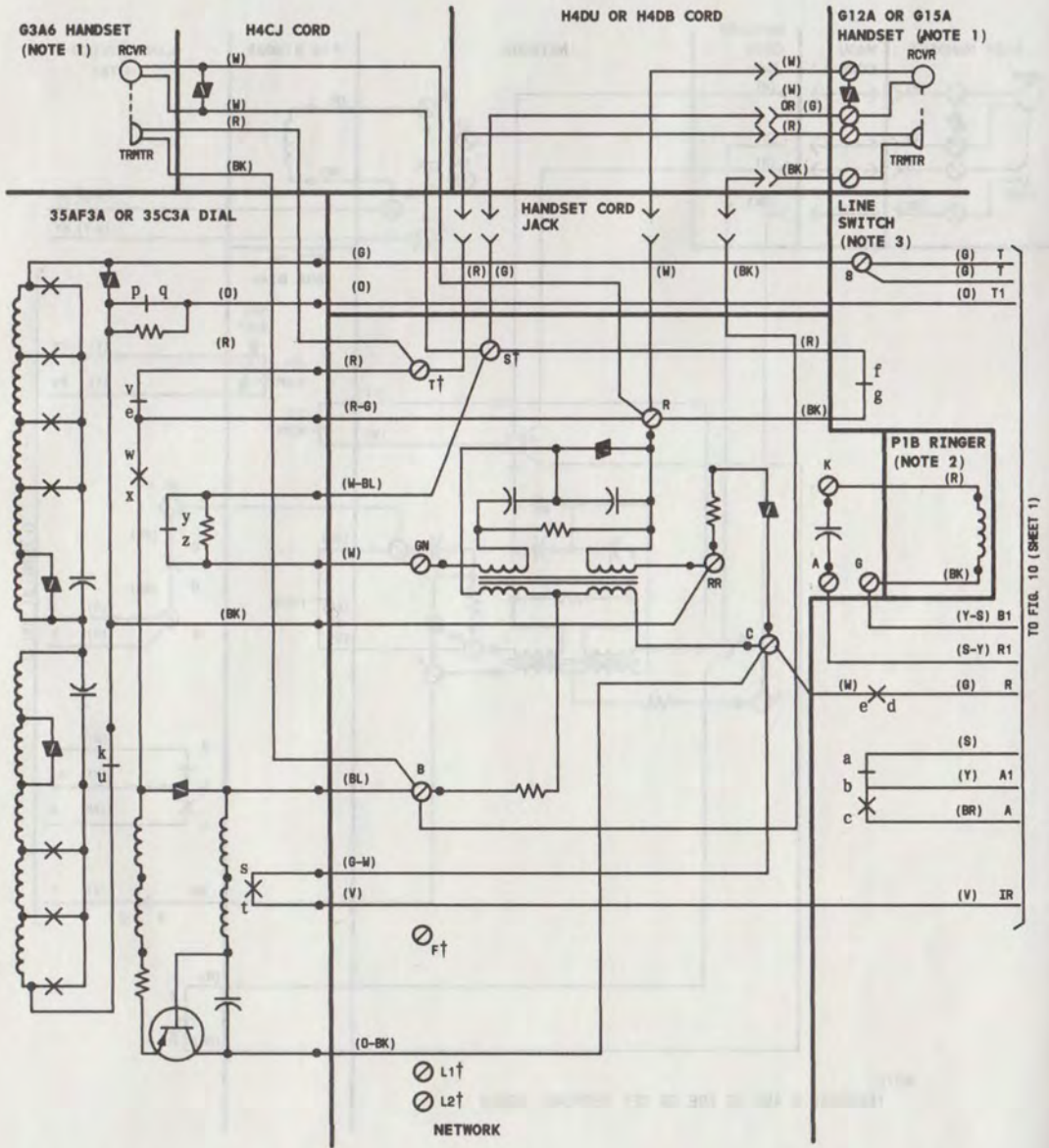
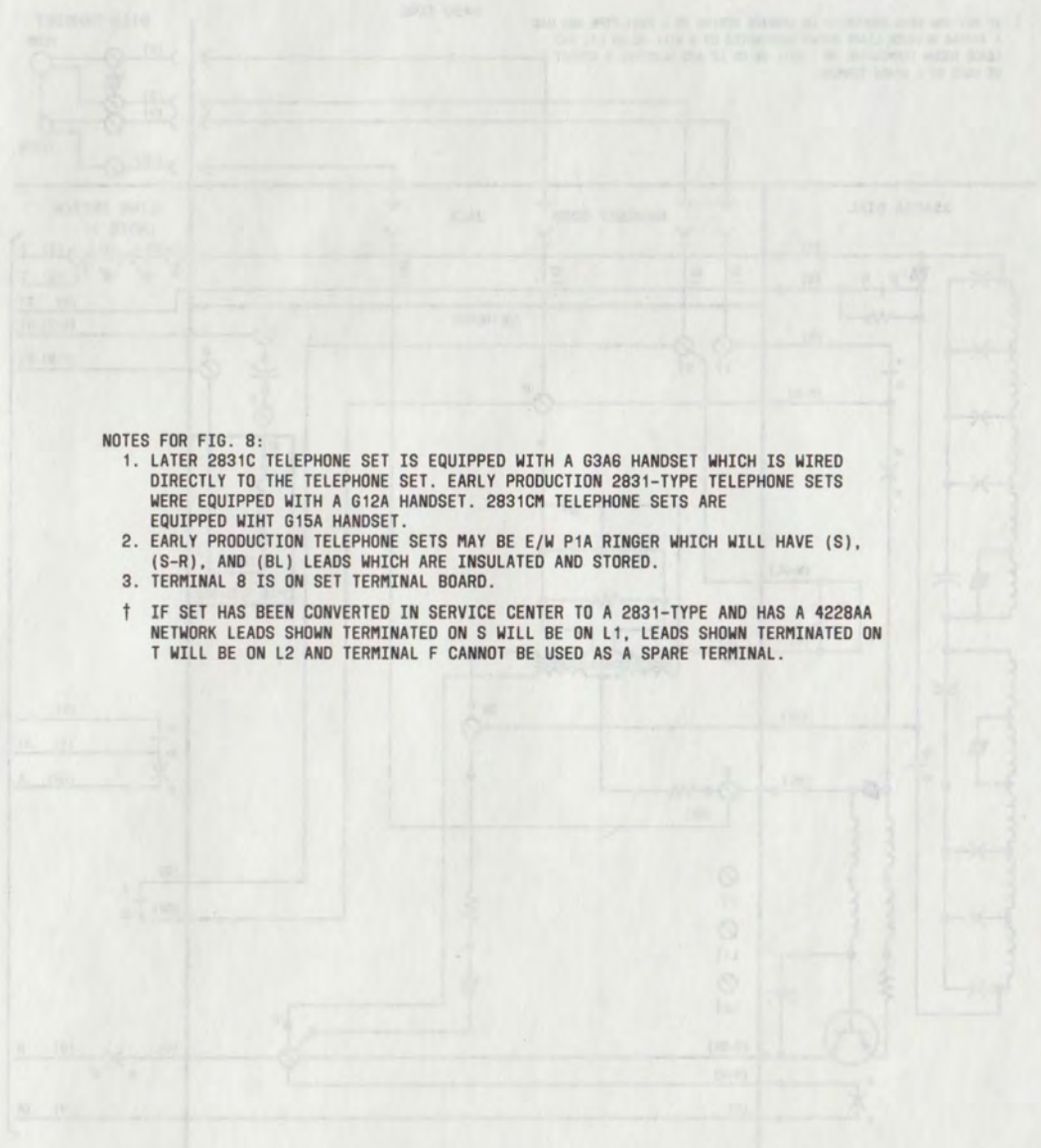

Fig. 8—Part of 2831A1M (MD), B1M (MD), C (MD), CT (MD), or CM (Equipped With Old Line Switch) Telephone Set, Connections



NOTES FOR FIG. 8:

1. LATER 2831C TELEPHONE SET IS EQUIPPED WITH A G3AG HANDSET WHICH IS WIRED DIRECTLY TO THE TELEPHONE SET. EARLY PRODUCTION 2831-TYPE TELEPHONE SETS WERE EQUIPPED WITH A G12A HANDSET. 2831CM TELEPHONE SETS ARE EQUIPPED WITH G15A HANDSET.
2. EARLY PRODUCTION TELEPHONE SETS MAY BE E/W P1A RINGER WHICH WILL HAVE (S), (S-R), AND (BL) LEADS WHICH ARE INSULATED AND STORED.
3. TERMINAL 8 IS ON SET TERMINAL BOARD.

† IF SET HAS BEEN CONVERTED IN SERVICE CENTER TO A 2831-TYPE AND HAS A 4228AA NETWORK LEADS SHOWN TERMINATED ON S WILL BE ON L1, LEADS SHOWN TERMINATED ON T WILL BE ON L2 AND TERMINAL F CANNOT BE USED AS A SPARE TERMINAL.

NOTES:

1. ON CM SETS MANUFACTURED BEFORE 2-77 AND EQUIPPED WITH NEW LINE SWITCH, TERMINALS 8 AND 16 ARE REVERSED.
2. TERMINAL 8 AND 16 ARE ON SET TERMINAL BOARD.

† IF SET HAS BEEN CONVERTED IN SERVICE CENTER TO A 2831-TYPE AND HAS A 4228AA NETWORK LEADS SHOWN TERMINATED ON S WILL BE ON L1, AND LEADS SHOWN TERMINATED ON T WILL BE ON L2 AND TERMINAL F CANNOT BE USED AS A SPARE TERMINAL

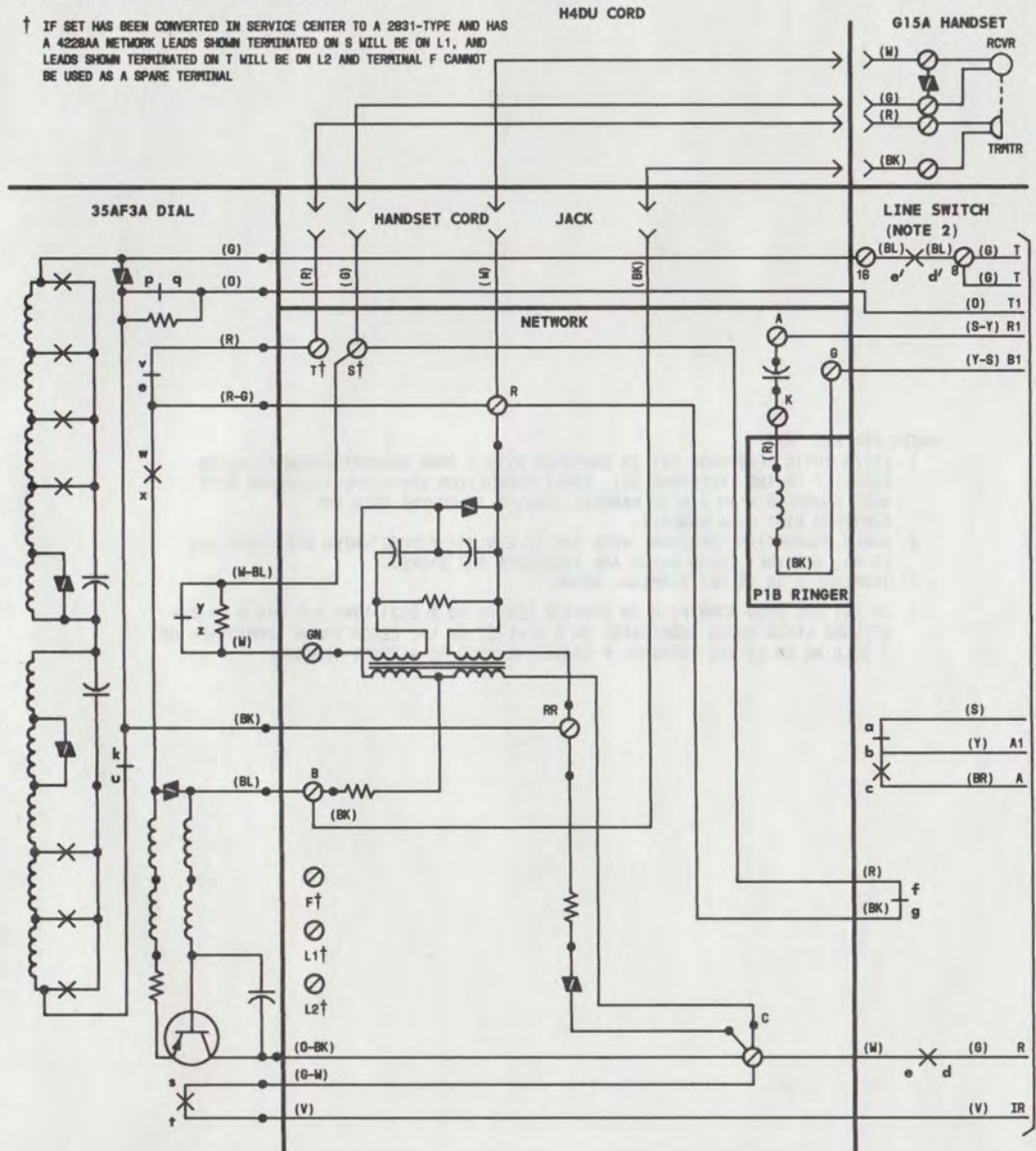
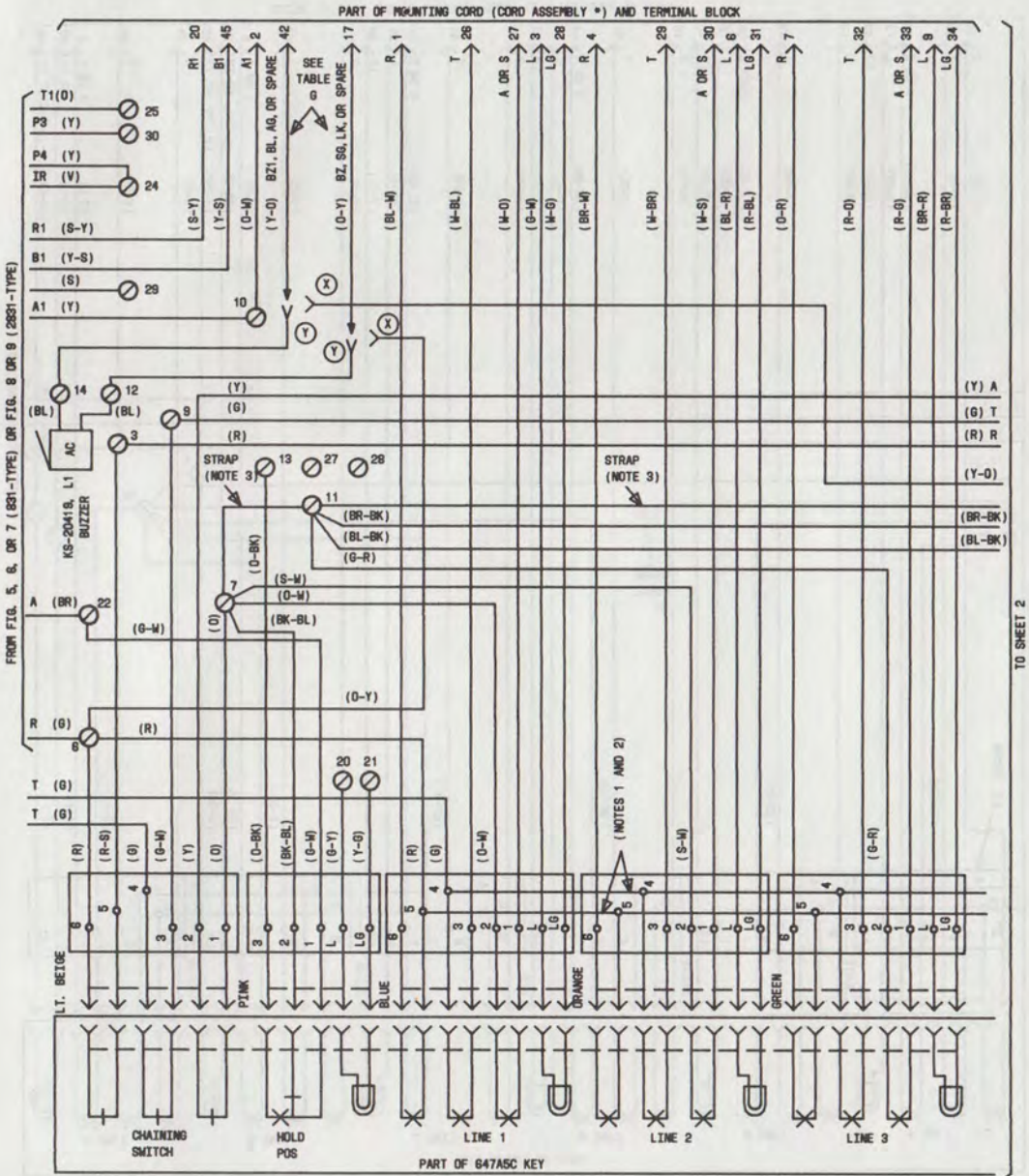

Fig. 9—Part of 2831CM (Equipped With New Line Switch) Telephone Set, Connections

TO FIG. 10 (SHEET 1)



FROM FIG. 5, 6, OR 7 (831-TYPE) OR FIG. 8 OR 9 (2831-TYPE)

TO SHEET 2

Fig. 10—831A1M (MD), B1M (MD), C (MD), CT (MD), CM or 2831A1M (MD), B1M (MD), C (MD), CT (MD), CM Telephone Set, Key and Mounting Cord Arrangement (Sheet 1 of 4)

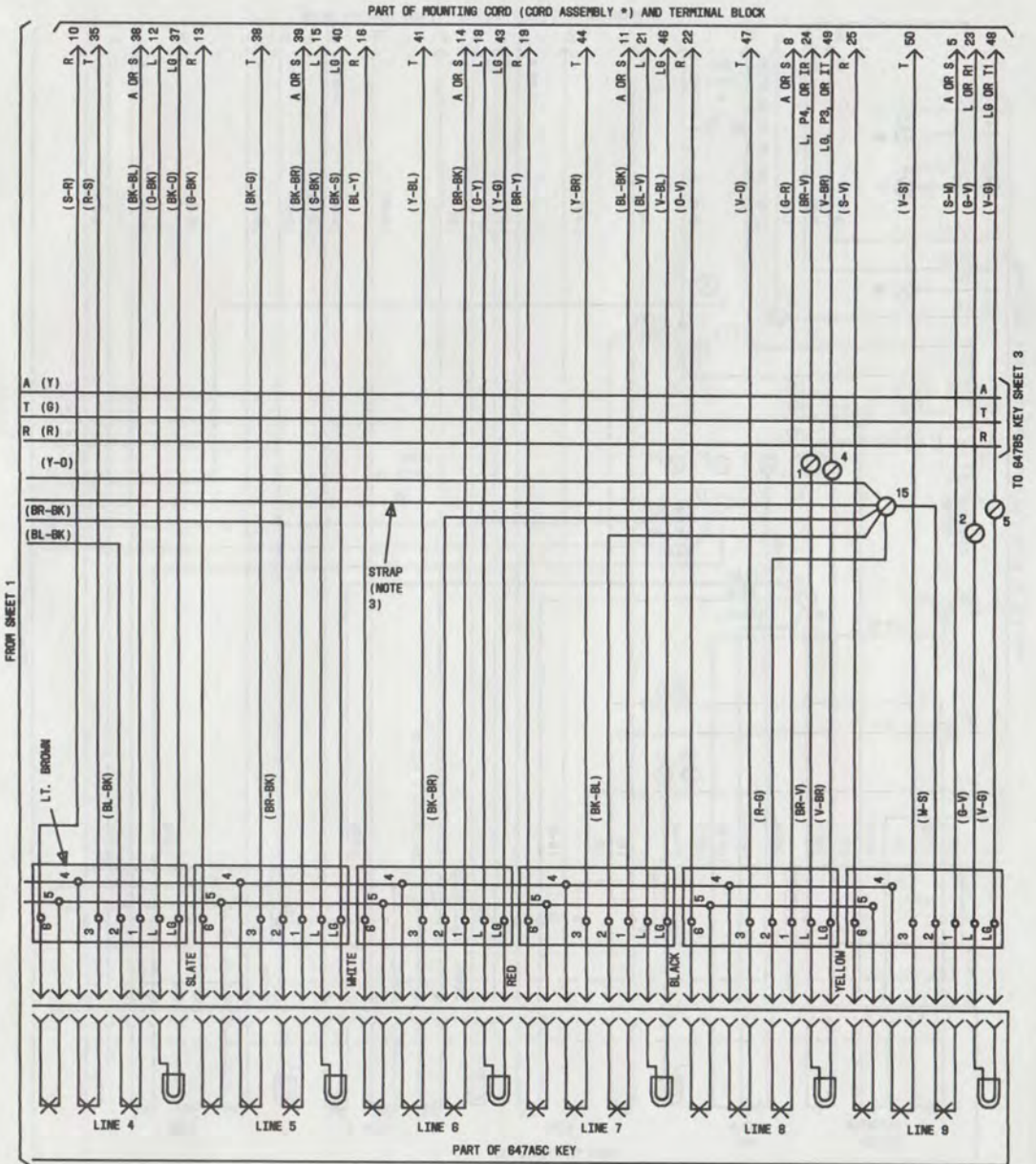

Fig. 10—831A1M (MD), B1M (MD), C (MD), CT (MD), CM or 2831A1M (MD), B1M (MD), C (MD), CT (MD), CM Telephone Set, Key and Mounting Cord Arrangement (Sheet 2 of 4)

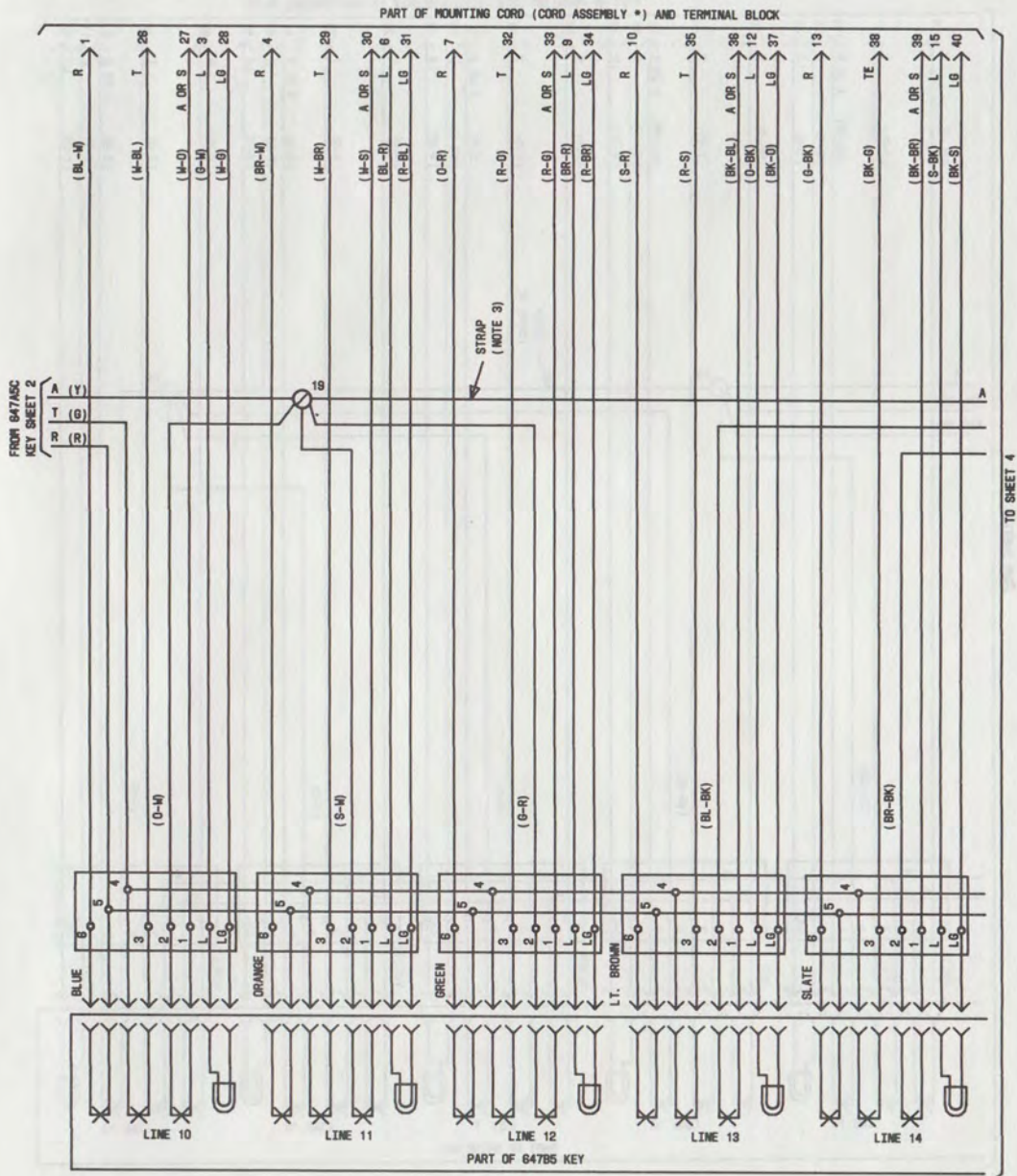

Fig. 10—831A1M (MD), B1M (MD), C (MD), CT (MD), CM or 2831A1M (MD), B1M (MD), C (MD), CT (MD), CM Telephone Set, Key and Mounting Cord Arrangement (Sheet 3 of 4)

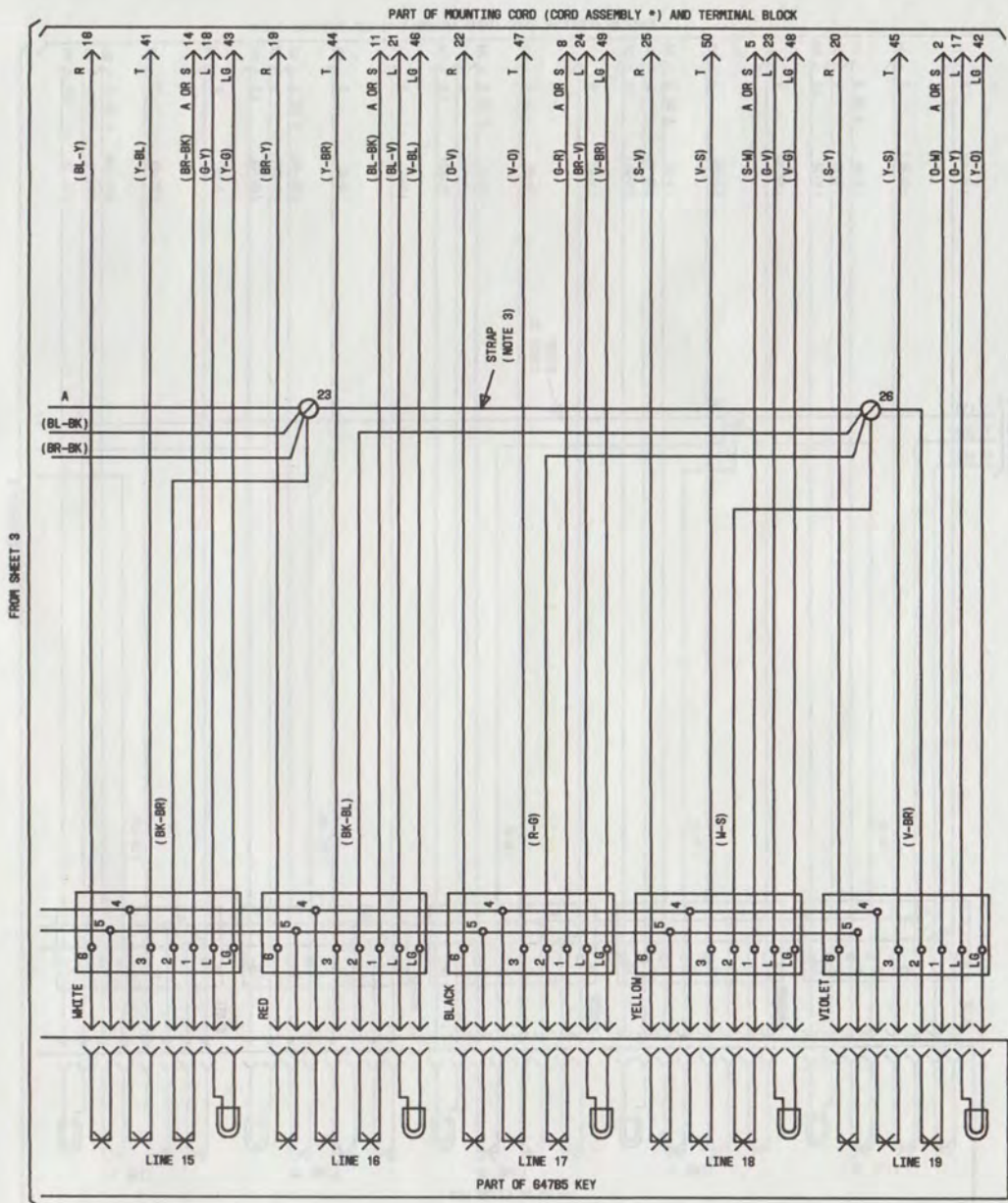
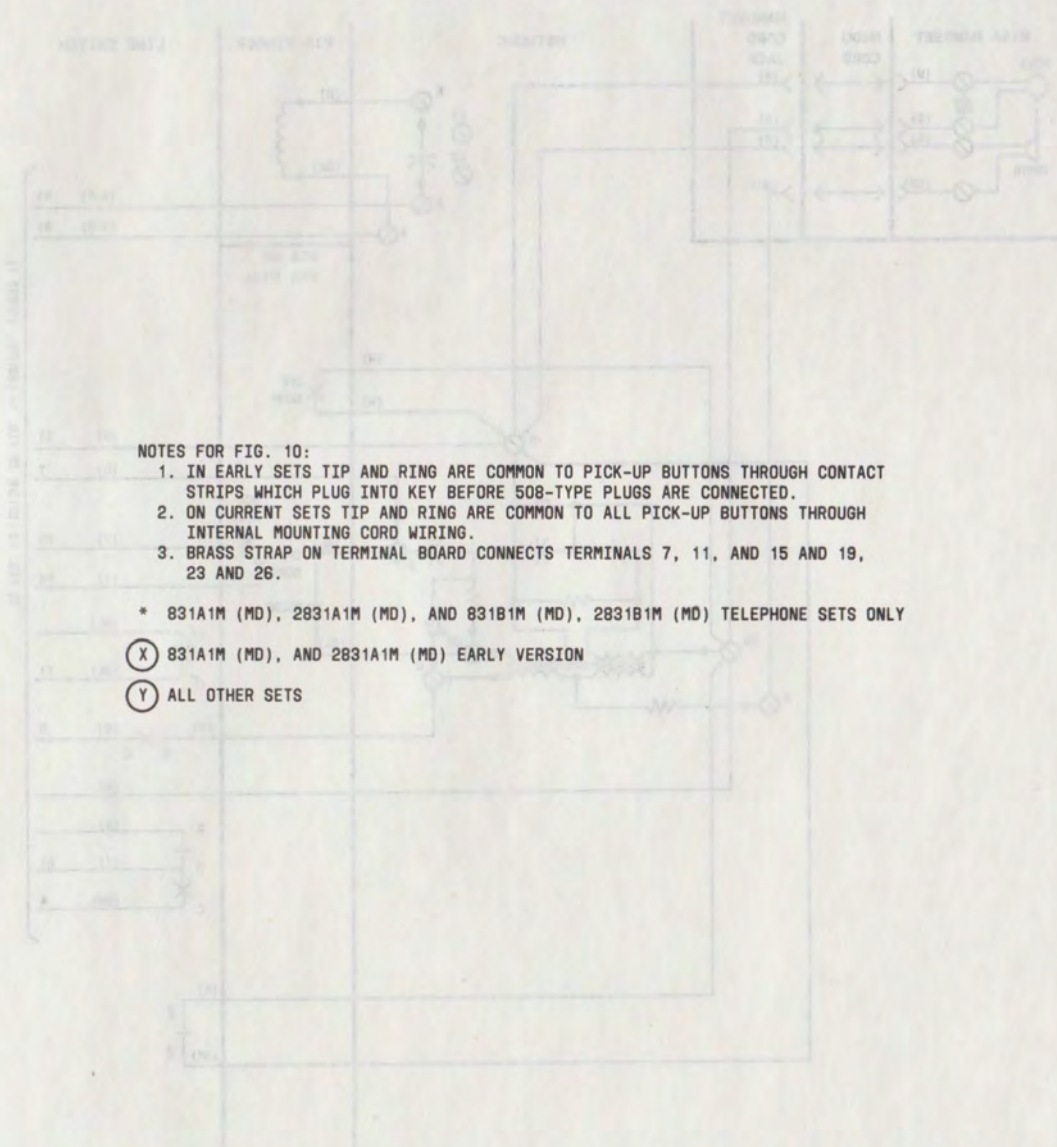

Fig. 10—831A1M (MD), B1M (MD), C (MD), CT (MD), CM or 2831A1M (MD), B1M (MD), C (MD), CT (MD), CM Telephone Set, Key and Mounting Cord Arrangement (Sheet 4 of 4)



NOTES FOR FIG. 10:

1. IN EARLY SETS TIP AND RING ARE COMMON TO PICK-UP BUTTONS THROUGH CONTACT STRIPS WHICH PLUG INTO KEY BEFORE 508-TYPE PLUGS ARE CONNECTED.
2. ON CURRENT SETS TIP AND RING ARE COMMON TO ALL PICK-UP BUTTONS THROUGH INTERNAL MOUNTING CORD WIRING.
3. BRASS STRAP ON TERMINAL BOARD CONNECTS TERMINALS 7, 11, AND 15 AND 19, 23 AND 26.

* 831A1M (MD), 2831A1M (MD), AND 831B1M (MD), 2831B1M (MD) TELEPHONE SETS ONLY

(X) 831A1M (MD), AND 2831A1M (MD) EARLY VERSION

(Y) ALL OTHER SETS

FIG. 10 - PART OF SET (MD) OR SET (MD) TELEPHONE Set, Connections

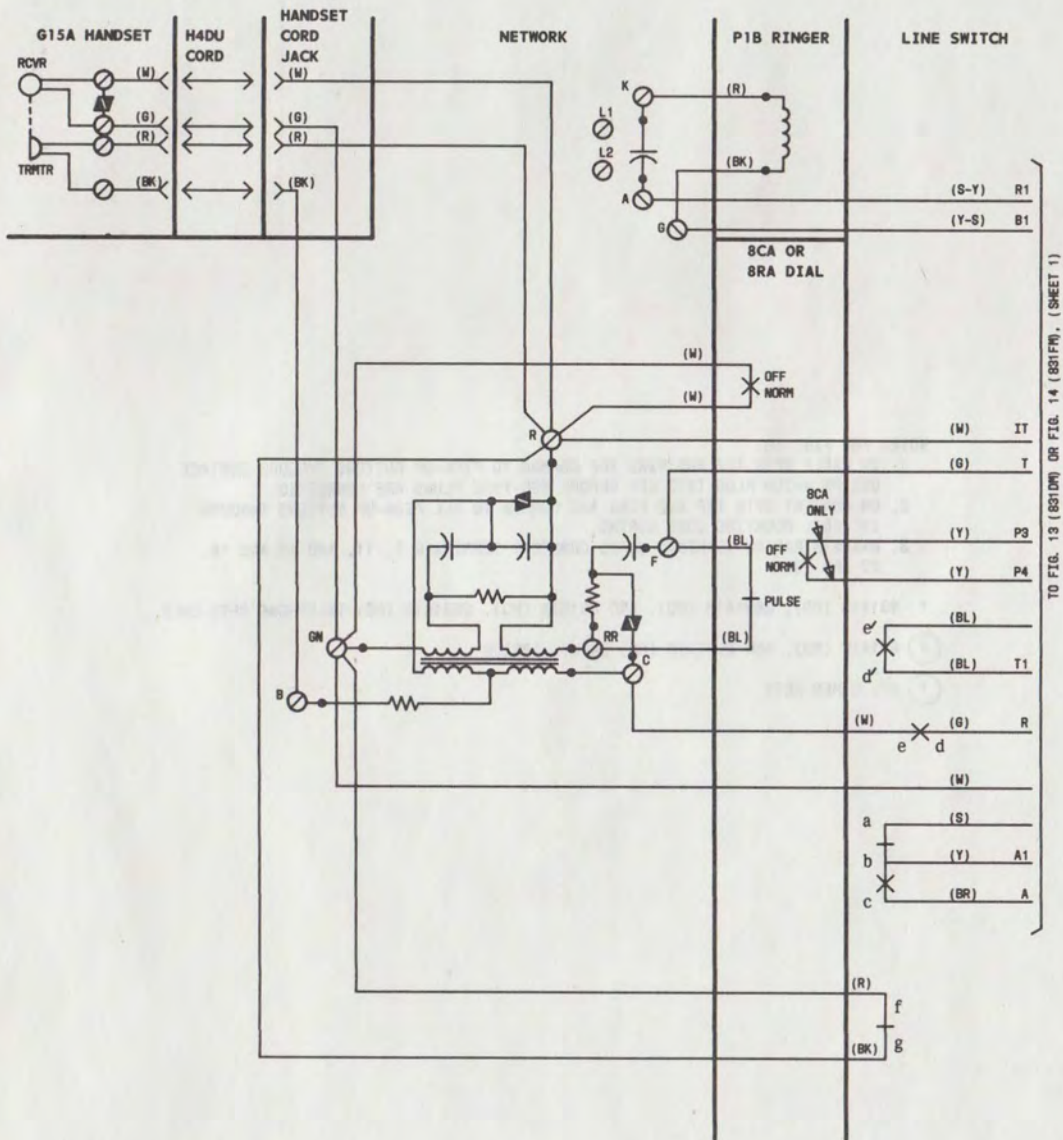

TO FIG. 13 (831DM) OR FIG. 14 (831FM), (SHEET 1)

Fig. 11—Part of 831DM (MD) or 831FM Telephone Set, Connections

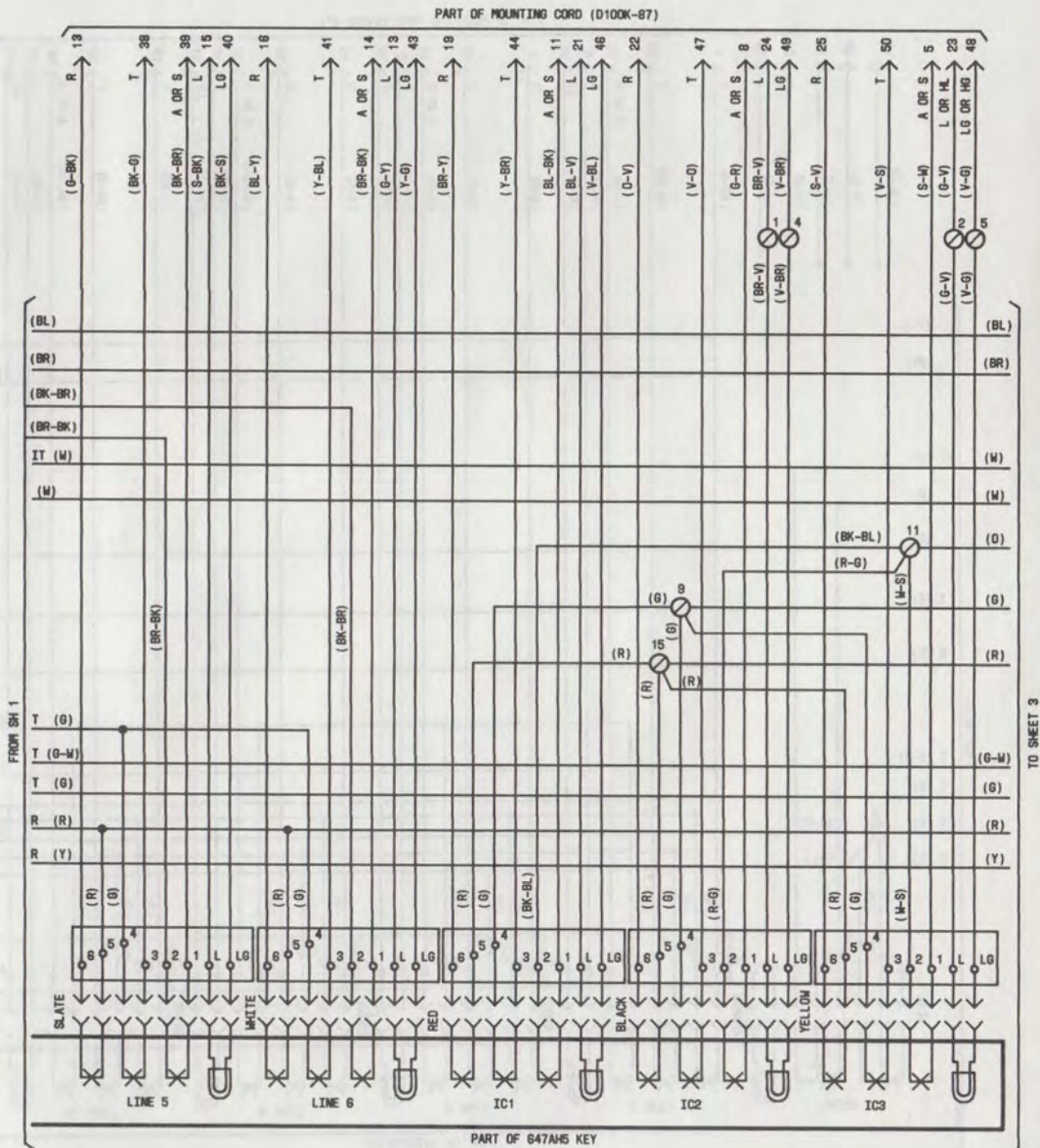

Fig. 13—831DM (MD) or 2831DM (MD) Telephone Set, Key and Mounting Cord Arrangement (Sheet 2 of 4)

PART OF MOUNTING CORD (D100K-87)

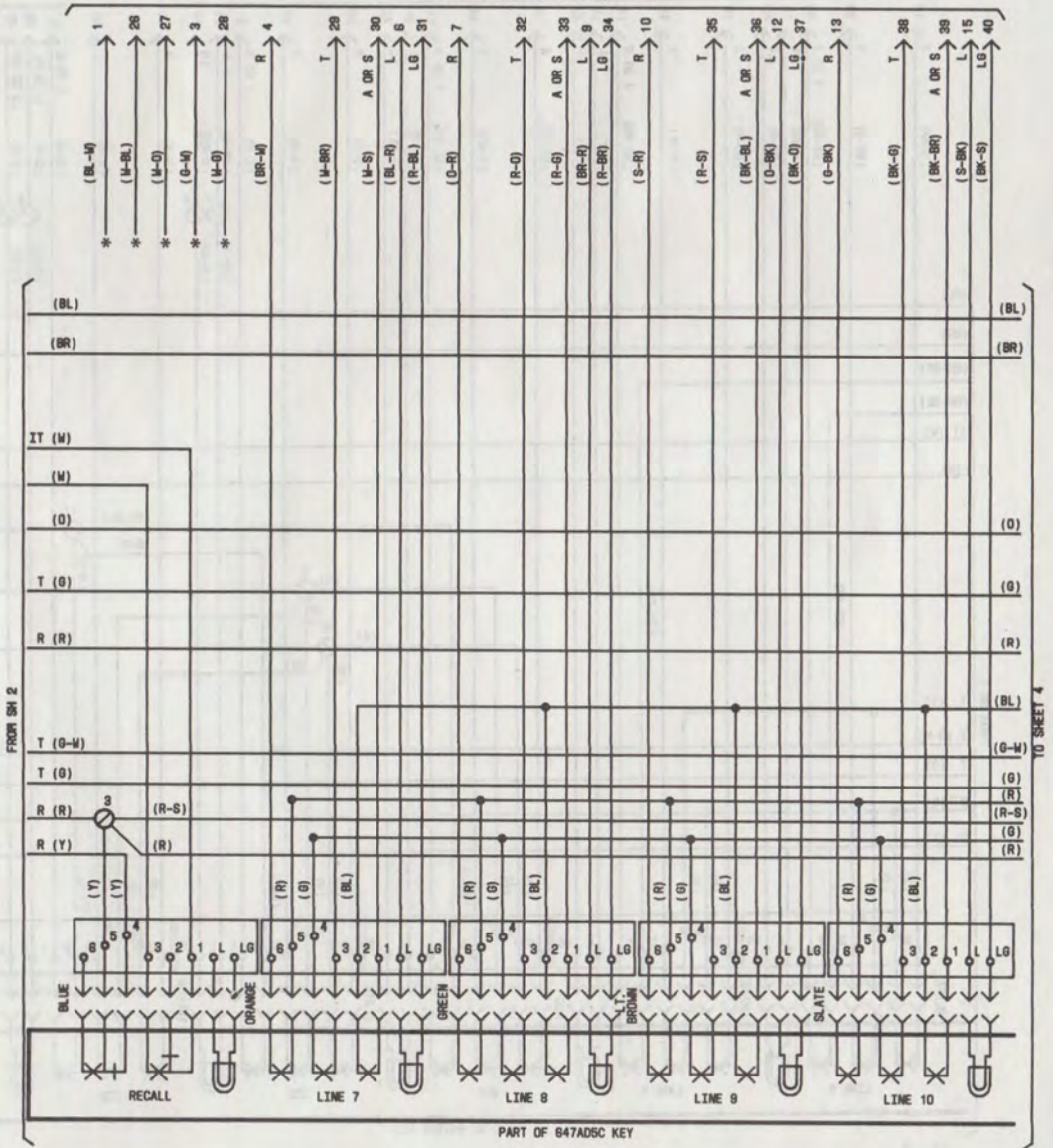

Fig. 13—831DM (MD) or 2831DM (MD) Telephone Set, Key and Mounting Cord Arrangement (Sheet 3 of 4)

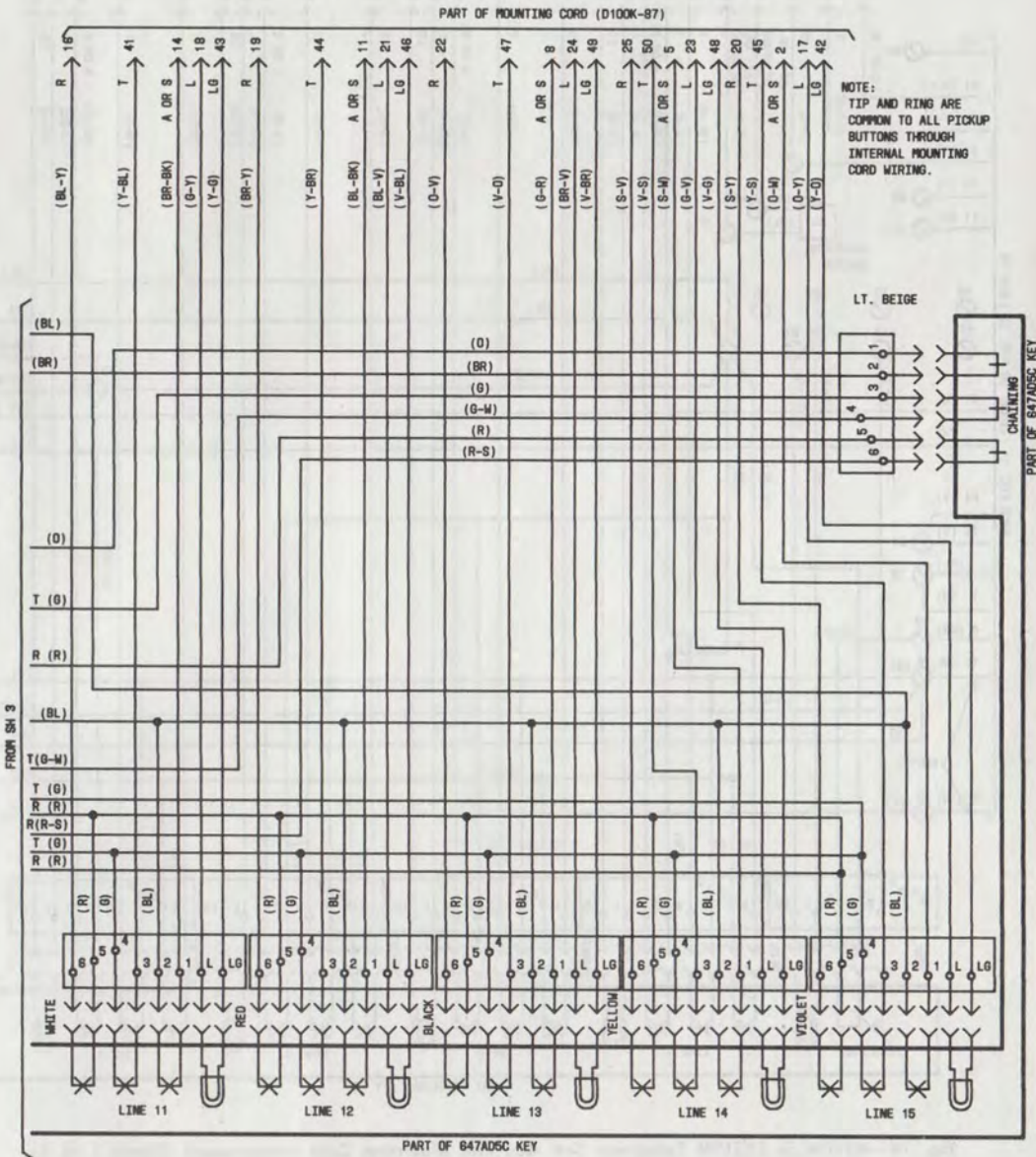

Fig. 13—831DM (MD) or 2831DM (MD) Telephone Set, Key and Mounting Cord Arrangement (Sheet 4 of 4)

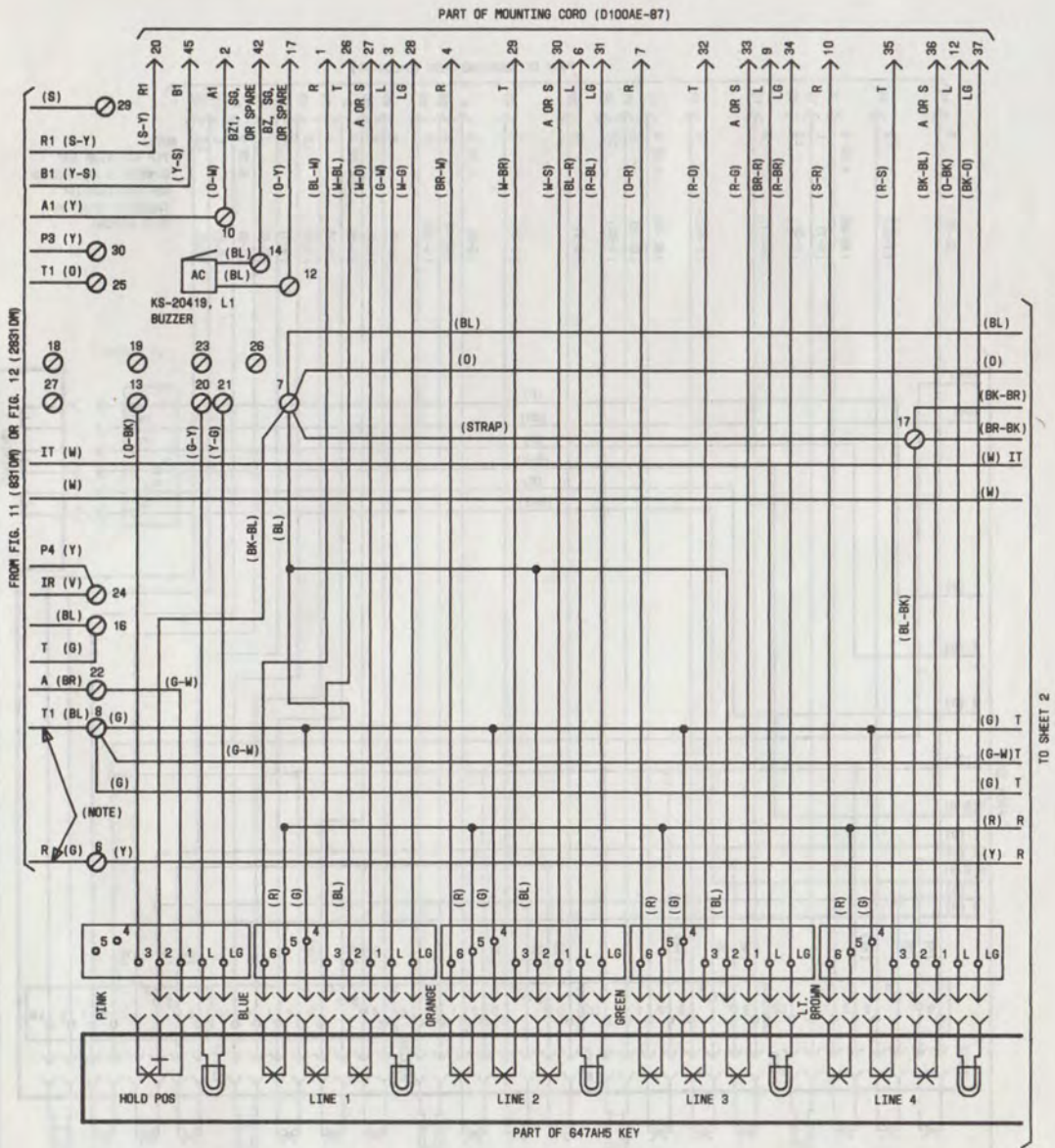

Fig. 14—831FM or 2831FM Telephone Set, Key and Mounting Cord Arrangement (Sheet 1 of 4)

PART OF MOUNTING CORD (D100AE-87)

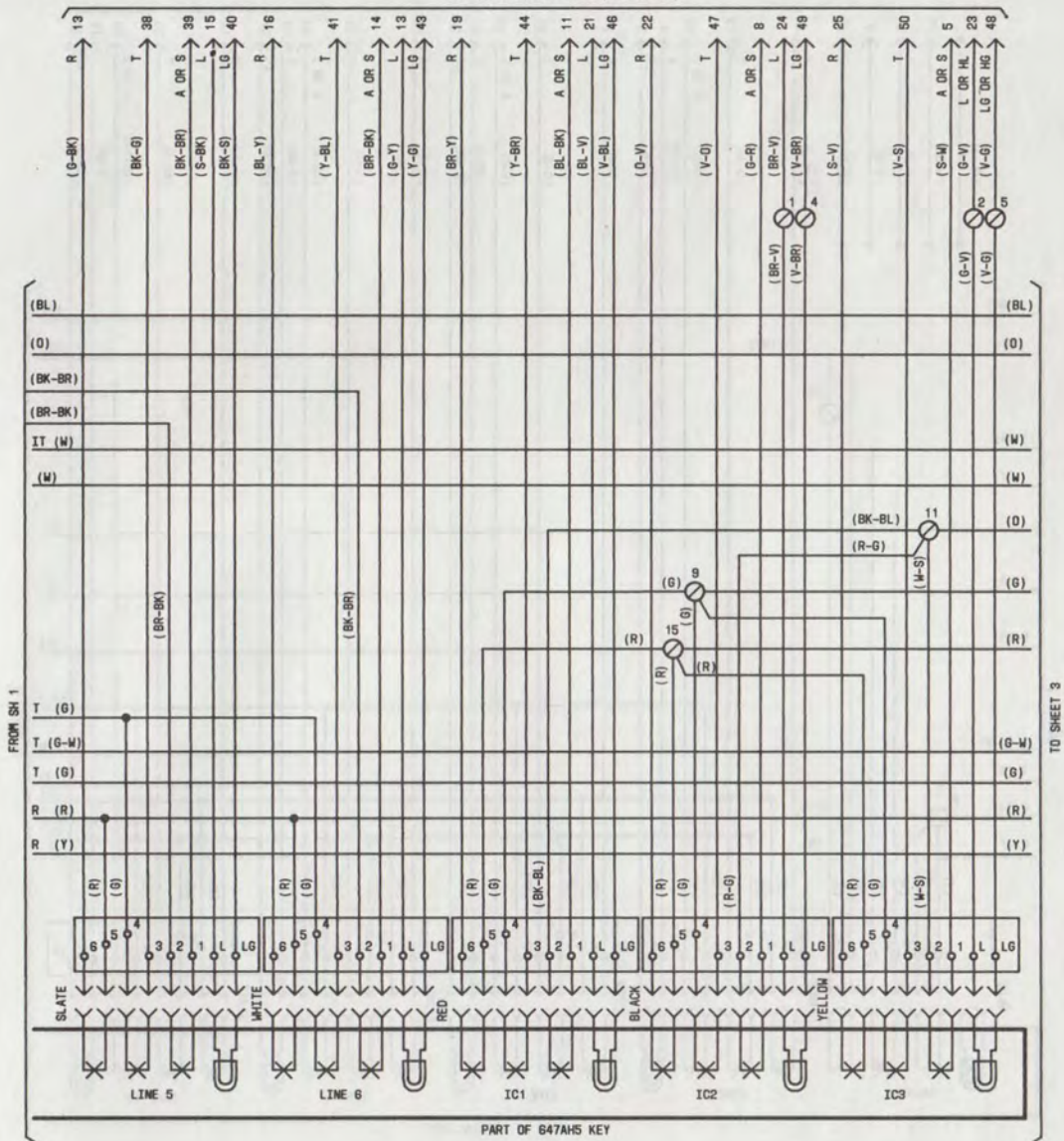

Fig. 14—831FM or 2831FM Telephone Set, Key and Mounting Cord Arrangement (Sheet 2 of 4)

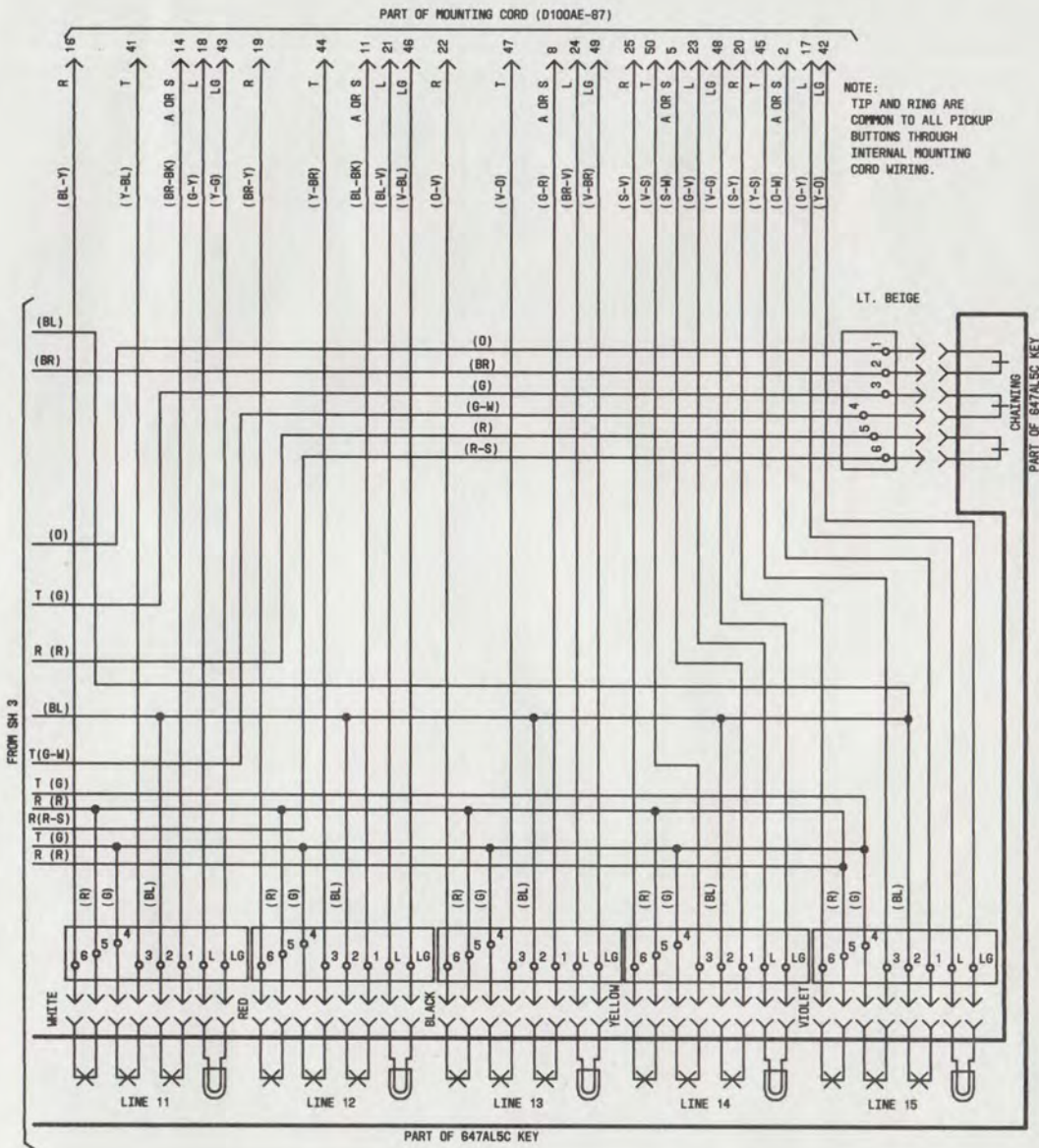

Fig. 14—831FM or 2831FM Telephone Set, Key and Mounting Cord Arrangement (Sheet 4 of 4)